

# ALUMINIUM-PROFILE

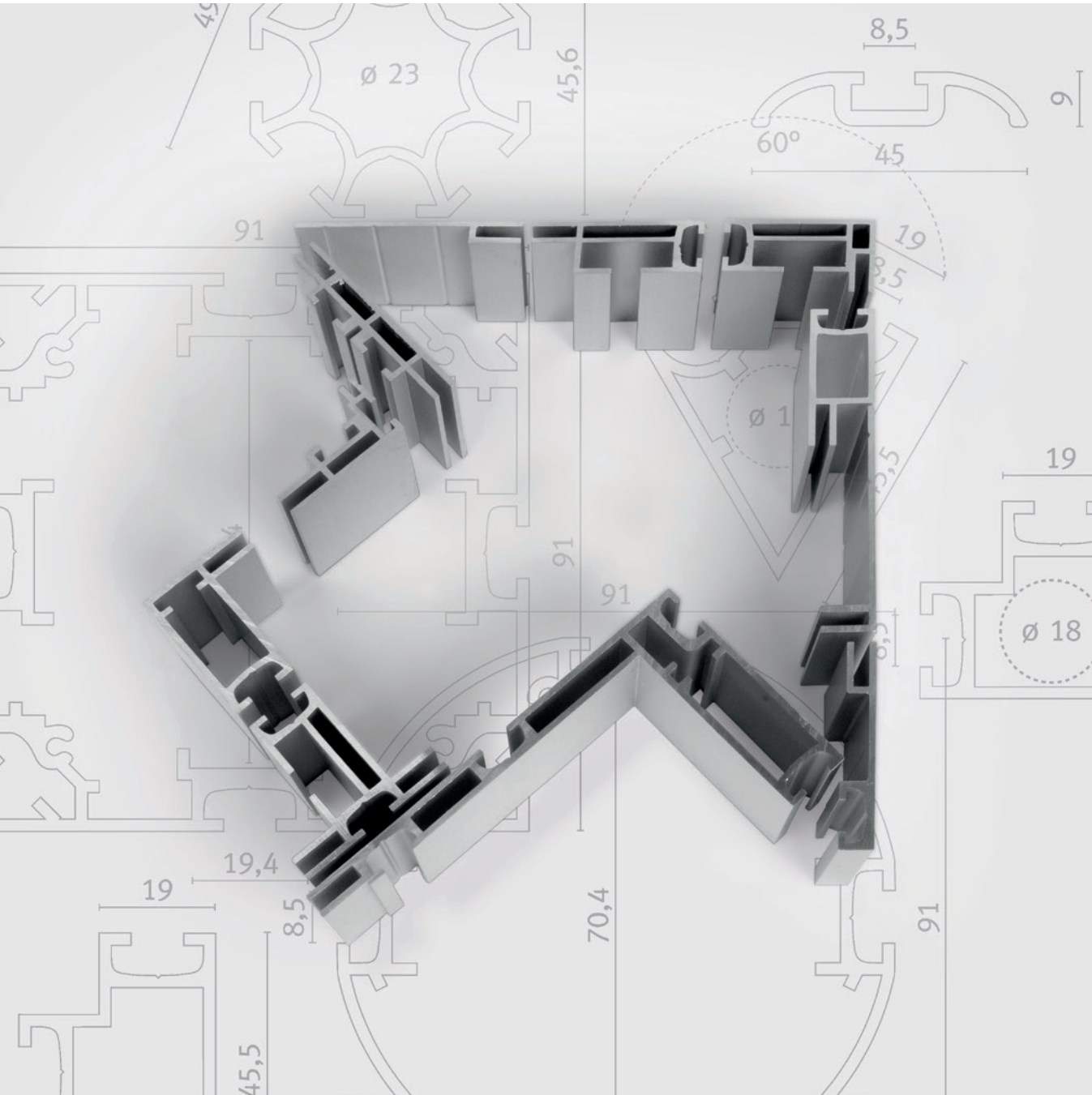

# ALUMINIU

# M-PROFILE

## Legende / Legend / Légende



**Biegen**  
Curving  
Profilé cintrable

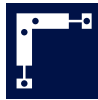

**winkel**  
corner plate  
équerre



**Längsverbinder**  
coupling  
manchon



**Gewicht**  
Weight  
Poids



**Montagezeit**  
Assembly time  
Temps de montage



**CBX Schloss**  
CBX Clip  
Pince CBX



**Inbusschlüssel**  
Allen Key  
Clé Allen



**Endkappe**  
End cap  
Embout



**Buchse**  
Socket  
Douille



**Transportierbar**  
Hand carryable  
Transportable



**Hintergrundbeleuchtung**  
edg lite  
Rétro-éclairé

**PX 3132**

**Stützprofil**  
 lieferbar bis 6 m Länge

**Upright profile**  
 max. length 6 m

**Montant**  
 Longueur max. 6 m

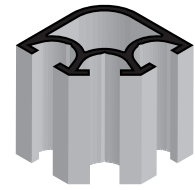
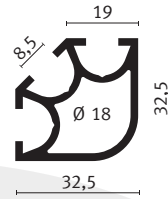

**PX 3232**

**Stützprofil**  
 lieferbar bis 6 m Länge

**Upright profile**  
 max. length 6 m

**Montant**  
 Longueur max. 6 m

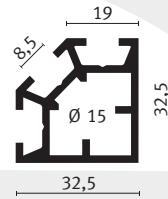

**PX 3332**

**Stützprofil**  
 lieferbar bis 6 m Länge

**Upright profile**  
 max. length 6 m

**Montant**  
 Longueur max. 6 m

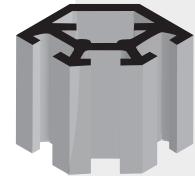
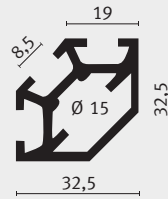

**PX 4135**

**Stützprofil**  
 lieferbar bis 6 m Länge

**Upright profile**  
 max. length 6 m

**Montant**  
 Longueur max. 6 m

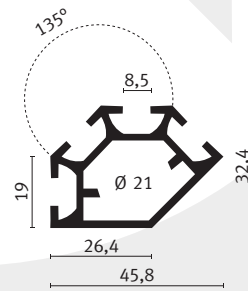

**PX 5019**

**Stützprofil**  
 lieferbar bis 6 m Länge

**Upright profile**  
 max. length 6 m

**Montant**  
 Longueur max. 6 m

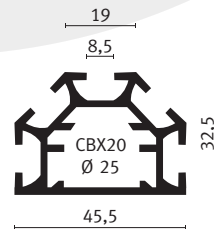



**S 80**

**Stützprofil**  
 lieferbar bis 6 m Länge

**Upright profile**  
 max. length 6 m

**Montant**  
 Longueur max. 6 m

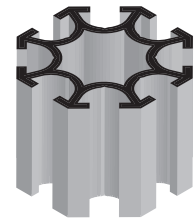
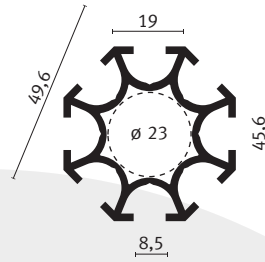

**GS 220**

**Stützprofil**  
 lieferbar bis 6 m Länge

**Upright profile**  
 max. length 6 m

**Montant**  
 Longueur max. 6 m

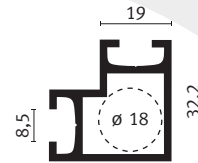

**GS 300**

**Stützprofil**  
 lieferbar bis 6 m Länge

**Upright profile**  
 max. length 6 m

**Montant**  
 Longueur max. 6 m

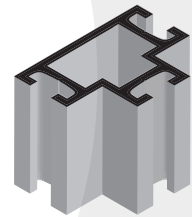
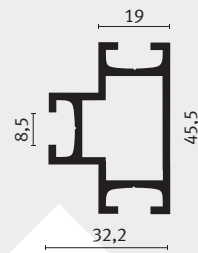

**S 28**

**Stützprofil**  
 lieferbar bis 6 m Länge

**Upright profile**  
 max. length 6 m

**Montant**  
 Longueur max. 6 m

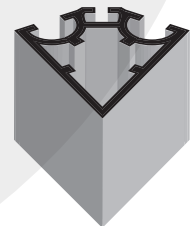
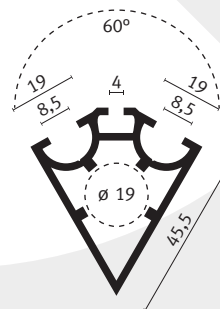

**PX 3120**

**Stützprofil**  
 lieferbar bis 6 m Länge

**Upright profile**  
 max. length 6 m

**Montant**  
 Longueur max. 6 m

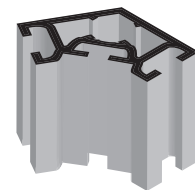
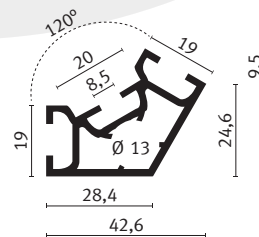

**PX 6019**

**Stützprofil**  
 lieferbar bis 6 m Länge

**Upright profile**  
 max. length 6 m

**Montant**  
 Longueur max. 6 m

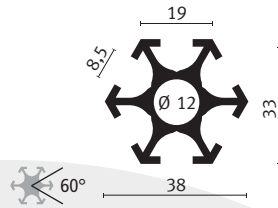

**PX 2145**

**Rundrohr Stützprofil**  
 lieferbar bis 6 m Länge

**Round upright profile**  
 max. length 6 m

**Montant rond**  
 Longueur max. 6 m

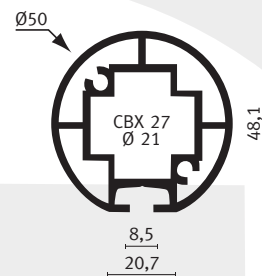

**PX 2045**

**Rundrohr Stützprofil**  
 lieferbar bis 6 m Länge

**Round upright profile**  
 max. length 6 m

**Montant rond**  
 Longueur max. 6 m

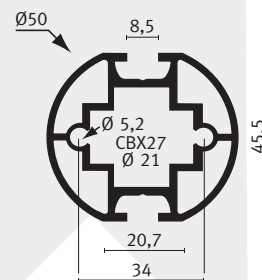

**RSG 520**

**Rundrohr Stützprofil**  
 lieferbar bis 6 m Länge

**Round upright profile**  
 max. length 6 m

**Montant rond**  
 Longueur max. 6 m

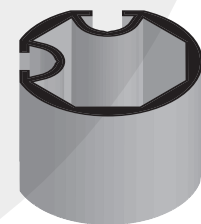
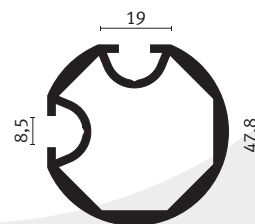

**PX 2445**

**Rundrohr Stützprofil**  
 lieferbar bis 6 m Länge

**Round upright profile**  
 max. length 6 m

**Montant rond**  
 Longueur max. 6 m

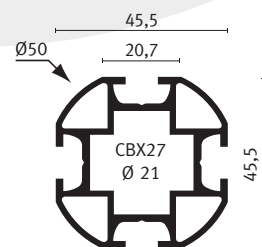

**PX 2345**

**Rundrohr  
 Stützprofil**

lieferbar bis 6 m Länge

**Round upright  
 profile**

max. length 6 m

**Montant rond**

Longueur max. 6 m

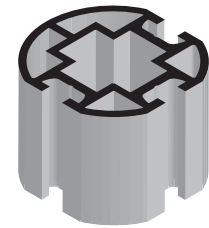
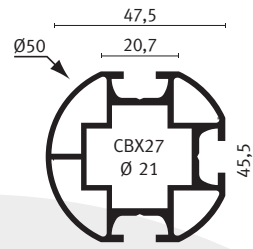

**PX 2245T**

**Rundrohr  
 Stützprofil**

lieferbar bis 6 m Länge

**Round upright  
 profile**

max. length 6 m

**Montant rond**

Longueur max. 6 m

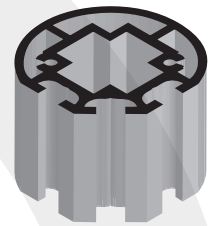
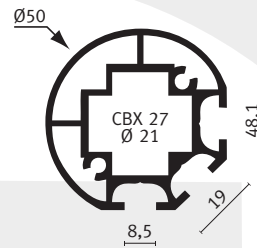

**PX 2545**

**Rundrohr  
 Stützprofil**

lieferbar bis 6 m Länge

**Round upright  
 profile**

max. length 6 m

**Montant rond**

Longueur max. 6 m

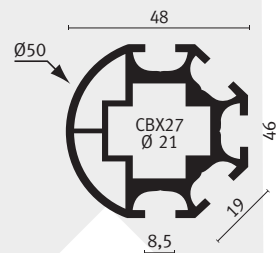

**RSG 560**

**Rundrohr  
 Stützprofil 60°**

lieferbar bis 6 m Länge

**Round upright  
 profile 60°**

max. length 6 m

**Montant rond  
 60°**

Longueur max. 6 m

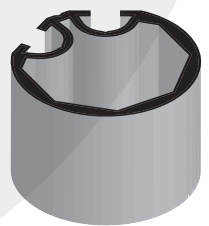
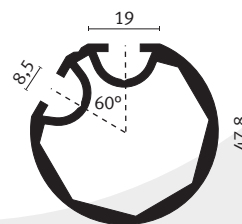

**RONDO**

**Rundrohr  
 Stützprofil**

lieferbar bis 6 m Länge

**Round upright  
 profile**

max. length 6 m

**Montant rond**

Longueur max. 6 m

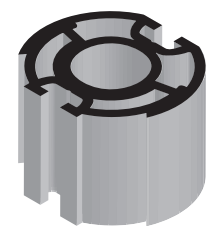
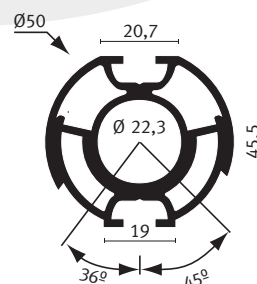

**PX 1525**

**Rundrohr  
 Stützprofil**

lieferbar bis 6 m Länge

**Round upright  
 profile**

max. length 6 m

**Montant rond**

Longueur max. 6 m

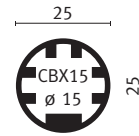

**MEGA R**

**Rundrohr Stützprofil**  
 lieferbar bis 6 m Länge

**Round upright profile**  
 max. length 6 m

**Montant rond**

longueur max. 6 m

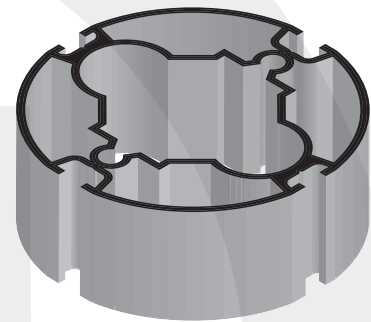
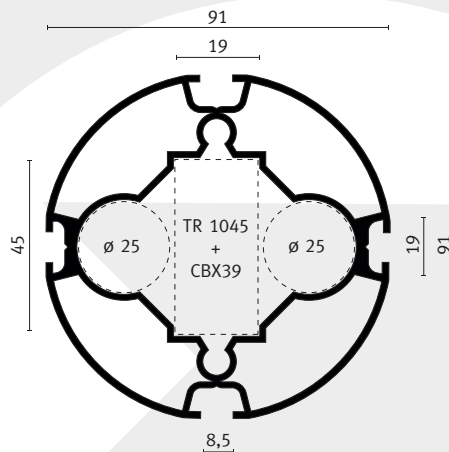

**MEGA RE**

**Rundrohr Stützprofil**  
 lieferbar bis 6 m Länge

**Round upright profile**  
 max. length 6 m

**Montant rond**

longueur max. 6 m

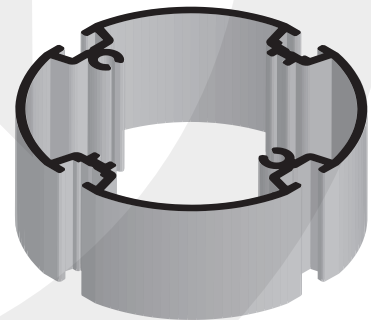
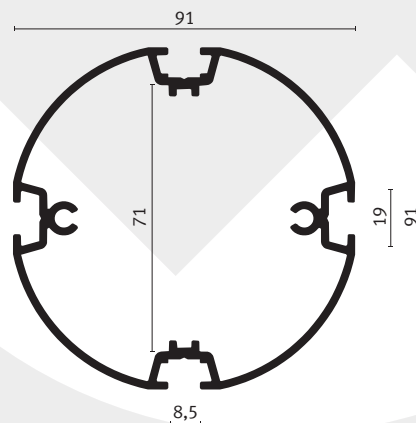

**RR 91**

**Rundrohr Stützprofil**  
 lieferbar bis 6 m Länge

**Round upright profile**  
 max. length 6 m

**Montant rond**

longueur max. 6 m

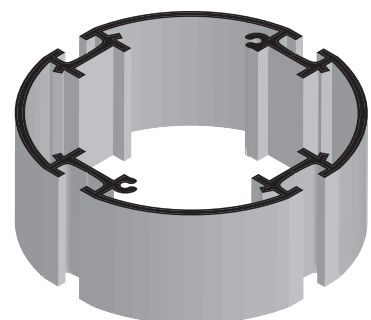
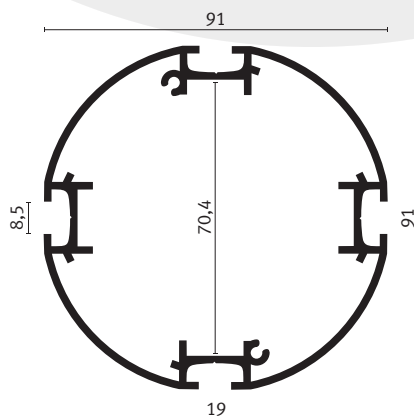

**PX 4026**

**Stützprofil**  
 lieferbar bis 6 m Länge

**Upright profile**  
 max. length 6 m

**Montant**  
 Longueur max. 6 m

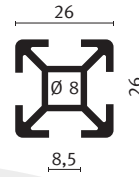

**PX 4032**

**Stützprofil**  
 lieferbar bis 6 m Länge

**Upright profile**  
 max. length 6 m

**Montant**  
 Longueur max. 6 m

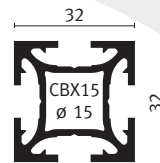

**S 44**

**Stützprofil**  
 lieferbar bis 6 m Länge

**Upright profile**  
 max. length 6 m

**Montant**  
 Longueur max. 6 m

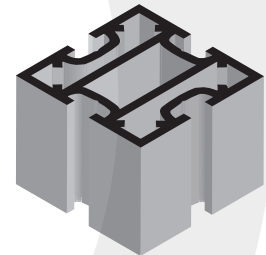
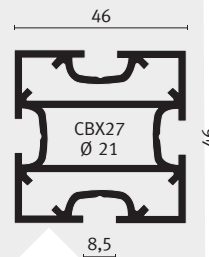

**PX 4045**

**Stützprofil**  
 lieferbar bis 6 m Länge

**Upright profile**  
 max. length 6 m

**Montant**  
 Longueur max. 6 m

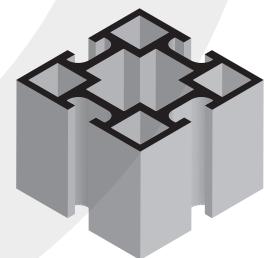
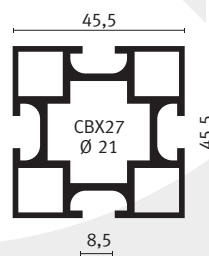

**S 47**

**Stützprofil**  
 lieferbar bis 6 m Länge

**Upright profile**  
 max. length 6 m

**Montant**  
 Longueur max. 6 m

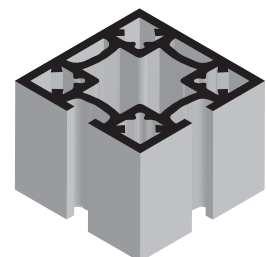
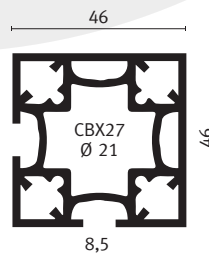

**TR 3245**

**Stützprofil**  
 lieferbar bis 6 m Länge

**Upright profile**  
 max. length 6 m

**Montant**  
 Longueur max. 6 m

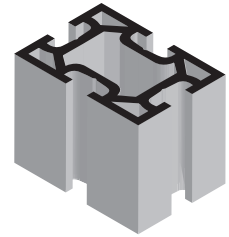
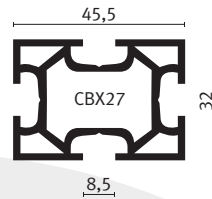

**PX 4345**

**Stützprofil**  
 lieferbar bis 6 m Länge

**Upright profile**  
 max. length 6 m

**Montant**  
 longueur max. 6 m

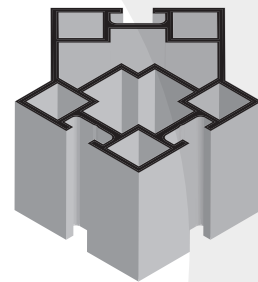
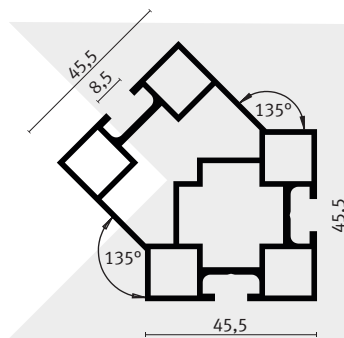

**PX 4060**

**Stützprofil**  
 lieferbar bis 6 m Länge

**Upright profile**  
 max. length 6 m

**Montant**  
 Longueur max. 6 m

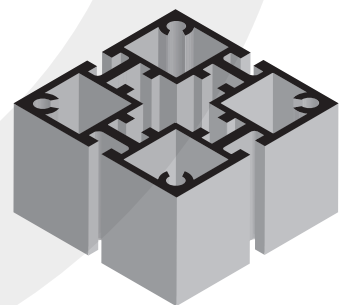
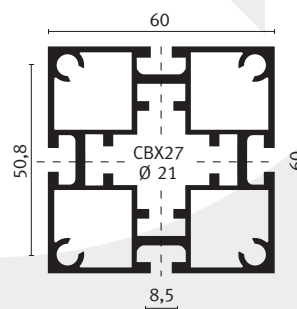

**MEGA M**

**Stützprofil**  
 lieferbar bis 6 m Länge

**Upright profile**  
 max. length 6 m

**Montant**  
 longueur max. 6 m

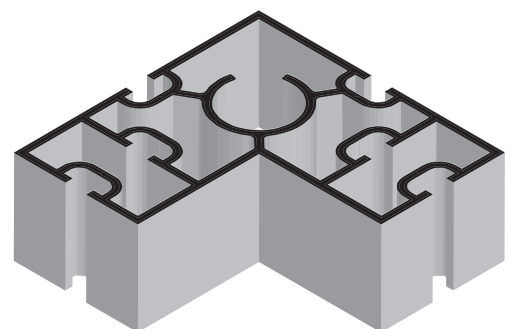
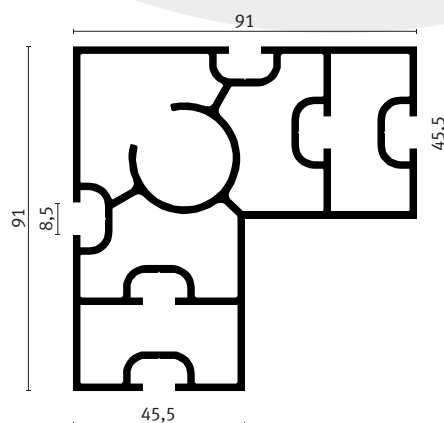

**Q 914**

**Stützprofil**  
 lieferbar bis 6 m Länge

**Upright profile**  
 max. length 6 m

**Montant**  
 longueur max. 6 m

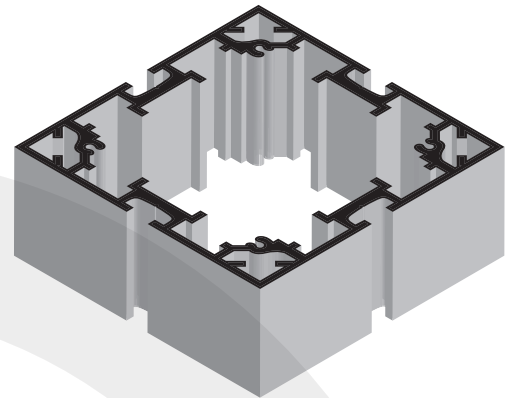
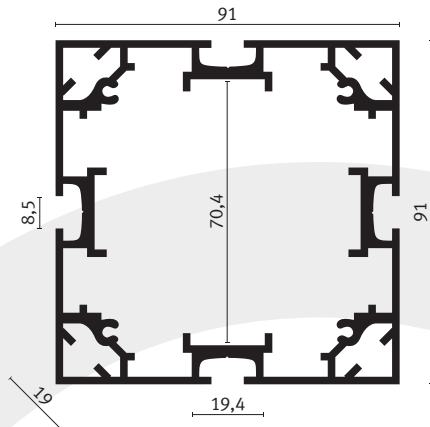

**P 1911**

**Zargenprofil**  
 lieferbar bis 6 m Länge

**Crossbeam profile**  
 max. length 6 m

**Profilè traverse**  
 Longueur max. 6 m

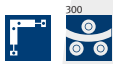

**Anwendungsbeispiel**  
 application example  
 exemple d'application

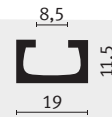
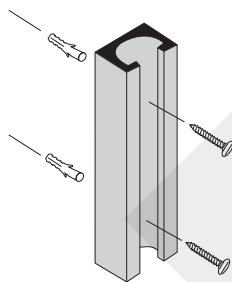

**P 1913**

**Zargenprofil**  
 lieferbar bis 6 m Länge

**Crossbeam profile**  
 max. length 6 m

**Profilè traverse**  
 Longueur max. 6 m

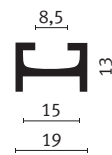

**P 1919**

**Zargenprofil**  
 lieferbar bis 6 m Länge

**Crossbeam profile**  
 max. length 6 m

**Profilè traverse**  
 Longueur max. 6 m

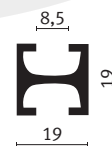
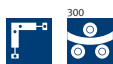

**TR 1032**

**Zargenprofil**

lieferbar bis 6 m Länge

**Crossbeam profile**

max. length 6 m

**Profilè traverse**

Longueur max. 6 m

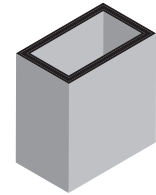

**Z 31**

**Zargenprofil**

lieferbar bis 6 m Länge

**Crossbeam profile**

max. length 6 m

**Profilè traverse**

Longueur max. 6 m

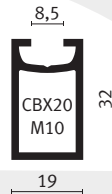

**TR 1932**

**Zargenprofil**

lieferbar bis 6 m Länge

**Crossbeam profile**

max. length 6 m

**Profilè traverse**

Longueur max. 6 m



**TR 1931**

**Zargenprofil**

lieferbar bis 6 m Länge

**Crossbeam profile**

max. length 6 m

**Profilè traverse**

Longueur max. 6 m

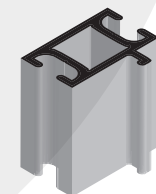
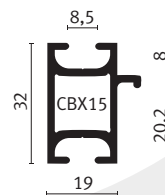

**TR 1045**

**Zargenprofil**

lieferbar bis 6 m Länge

**Crossbeam profile**

max. length 6 m

**Profilè traverse**

Longueur max. 6 m

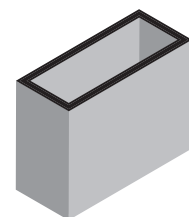



**Z 41**

**Zargenprofil**

lieferbar bis 6 m Länge

**Crossbeam profile**

max. length 6 m

**Profilè traverse**

Longueur max. 6 m

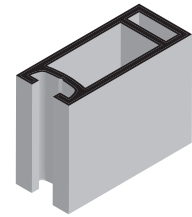

**TR 1945**

**Zargenprofil**

lieferbar bis 6 m Länge

**Crossbeam profile**

max. length 6 m

**Profilè traverse**

Longueur max. 6 m

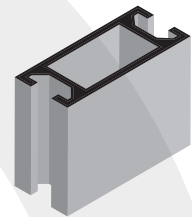

**TR 1951**

**Zargenprofil**

lieferbar bis 6 m Länge

**Crossbeam profile**

max. length 6 m

**Profilè traverse**

Longueur max. 6 m

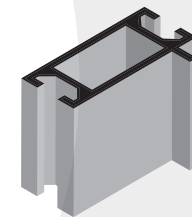
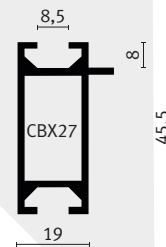

**TR 1952**

**Zargenprofil**

lieferbar bis 6 m Länge

**Crossbeam profile**

max. length 6 m

**Profilè traverse**

Longueur max. 6 m

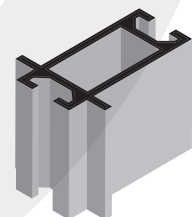
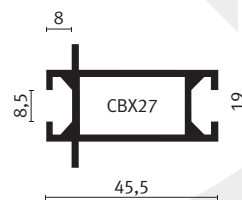

**TR 1960**

**Zargenprofil**

lieferbar bis 6 m Länge

**Crossbeam profile**

max. length 6 m

**Profilè traverse**

Longueur max. 6 m

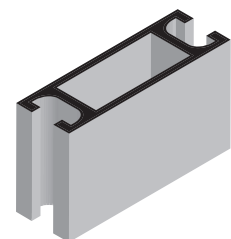

**Z 72**

**Zargenprofil**

lieferbar bis 6 m Länge

**Crossbeam profile**

max. length 6 m

**Profilè traverse**

Longueur max. 6 m

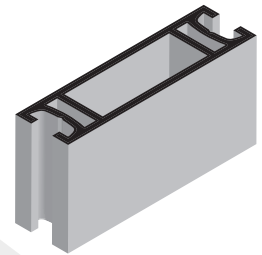

**TR 1970 B**

**Zargenprofil**

lieferbar bis 6 m Länge

**Crossbeam profile**

max. length 6 m

**Profilè traverse**

Longueur max. 6 m

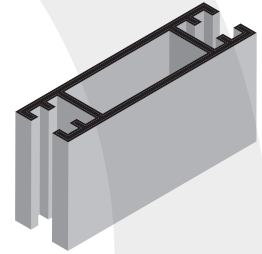

**TR 1971**

**Zargenprofil**

lieferbar bis 6 m Länge

**Crossbeam profile**

max. length 6 m

**Profilè traverse**

Longueur max. 6 m

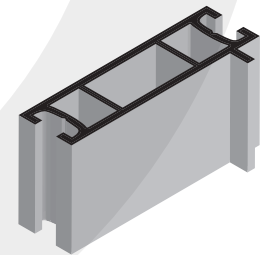
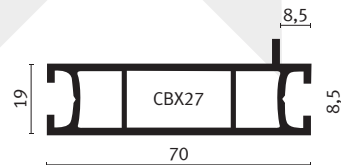

**TR 1973**

**Zargenprofil**

lieferbar bis 6 m Länge

**Crossbeam profile**

max. length 6 m

**Profilè traverse**

Longueur max. 6 m

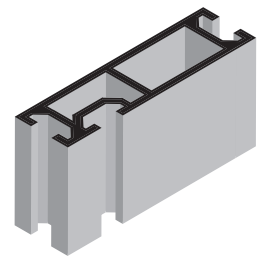
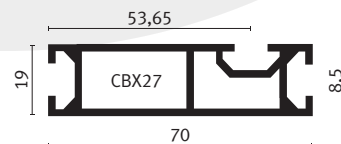

**TR 1904**

**Zargenprofil**

lieferbar bis 6 m Länge

**Crossbeam profile**

max. length 6 m

**Profilè traverse**

Longueur max. 6 m

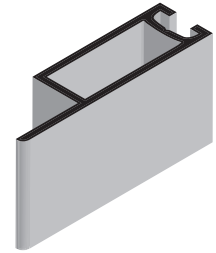
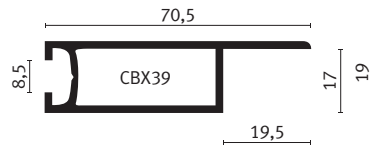

**TR 1993**

**Zargenprofil**

lieferbar bis 6 m Länge

**Crossbeam profile**

max. length 6 m

**Profilè traverse**

Longueur max. 6 m

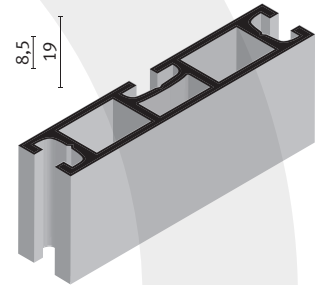
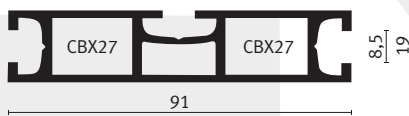

**Z 140**

**Zargenprofil**

lieferbar bis 6 m Länge

**Crossbeam profile**

max. length 6 m

**Profilè traverse**

longueur max. 6 m

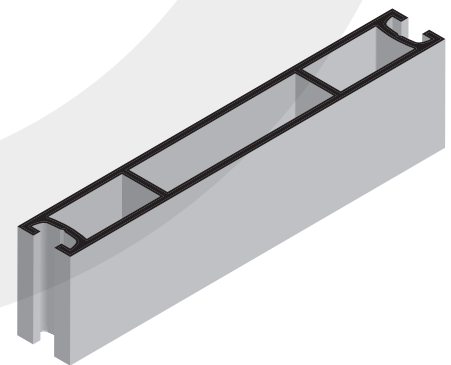

**TR 1920**

**Zargenprofil**

lieferbar bis 6 m Länge

**Crossbeam profile**

max. length 6 m

**Profilè traverse**

Longueur max. 6 m

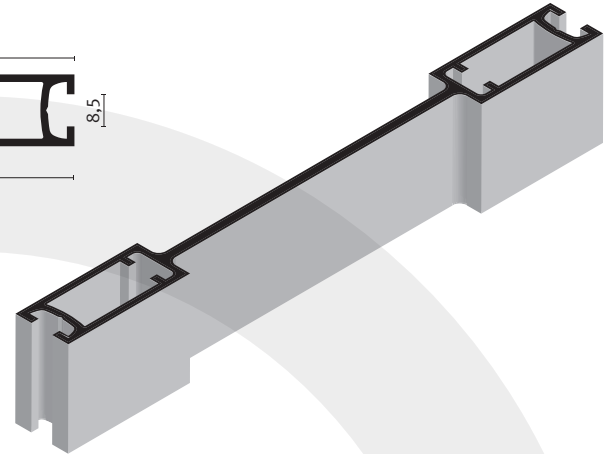
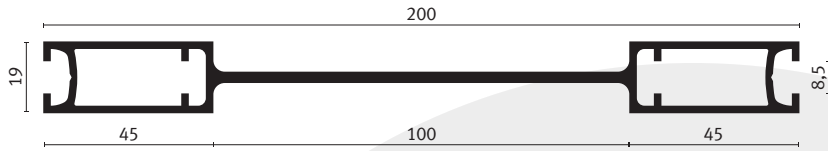

**TO 35**

**Zargenprofil**

lieferbar bis 6 m Länge

**Crossbeam profile**

max. length 6 m

**Profilè traverse**

Longueur max. 6 m



**PAL**

**Klemmprofil**

lieferbar bis 6 m Länge

**H-profile**

max. length 6 m

**Profilè de liaison**

longueur max. 6 m

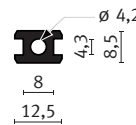

**Anwendungsbeispiel**

application example  
 exemple d'application

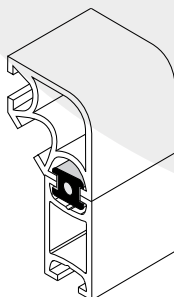

**BR 8**

**Abdichtleiste**

lieferbar bis 6 m Länge

**Groove filler**

max. length 6 m

**Bouche rainure**

Longueur max. 6 m

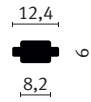

**BR 19**

**Abdichtleiste**

lieferbar bis 6 m Länge

**Groove filler**

max. length 6 m

**Bouche rainure**

Longueur max. 6 m

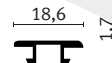

**BA 19**

**Anschlagleiste**

lieferbar bis 6 m Länge  
 für 19 mm Platte

**Aluminium  
 door stop**

max. length 6 m  
 for 19 mm panel

**Profilè battue  
 de porte**

Longueur max. 6 m  
 pour panneaux de 19 mm

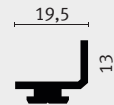

**SP 19**

**Einseitige  
 Auflageleiste**

lieferbar bis 6 m Länge

**Single  
 support**

max. length 6 m

**Profilè support  
 plateau**

longueur max. 6 m

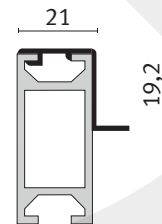

**SPD 19**

**Doppelseitige  
 Auflageleiste**

lieferbar bis 6 m Länge

**Double  
 support**

max. length 6 m

**Profilè support  
 plateau double**

longueur max. 6 m

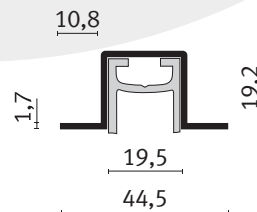

**UP 19**

**Wandaufnahmeprofil**

lieferbar bis 6 m Länge

**Aluminium panel  
 retainer**

max. length 6 m

**Profilé support  
 panneau**

longueur max. 6 m

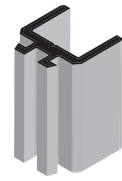
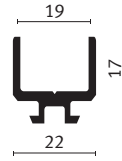

**BA 26**

**Türanschlagleiste**

lieferbar bis 6 m Länge

**Aluminium  
 door stop**

max. length 6 m

**Profilé battue  
 de porte**

Longueur max. 6 m

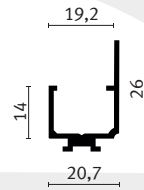

**PSA**

**Zusatznutprofil**

lieferbar bis 6 m Länge

**Additional  
 groove**

max. length 6 m

**Profilé pour rainure  
 supplémentaire**

longueur max. 6 m

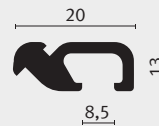

**Anwendungsbeispiel**

application example  
 exemple d'application

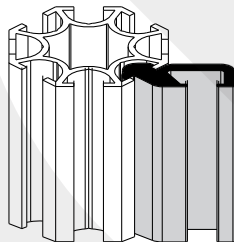

**BS 45**

**Türschwellenprofil**

lieferbar bis 6 m Länge

**Aluminium  
 threshold**

max. length 6 m

**Barre  
 de seuil**

Longueur max. 6 m

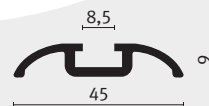

**S 88 2**

**Schwenkbare  
 Kammer**

lieferbar bis 6 m Länge

**Upright profile**

max. length 6 m

**Rainure  
 orientable**

Longueur max. 6 m



**PCHR 1**

**Scharnierprofil**

lieferbar bis 6 m Länge

**Cogwheel**

max. length 6 m

**Profilé charnière**

longueur max. 6 m



**Anwendungsbeispiel**

application example  
 exemple d'application

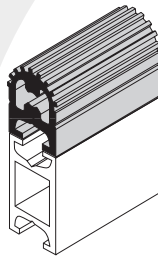

**PCHR 2**

**Scharnierprofil**

lieferbar bis 6 m Länge

**Cogwheel**

max. length 6 m

**Profilé charnière**

longueur max. 6 m

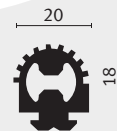

**VBAL 19**

**Verlegeboden-  
 Abschlussleiste**

für 19 mm Bodenplatten  
 lieferbar bis 6 m Länge

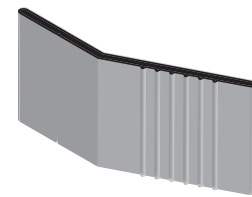
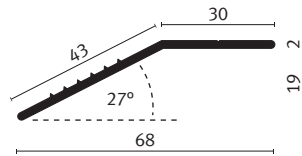

**Covering profile**

for 19 mm floor boards  
 max. length 6 m

**Profilè finition**

pour plancher de  
 hauteur 19 mm  
 longueur max. 6 m

**VBAL 38**

**Verlegeboden-  
 Abschlussleiste**

für 38 mm Platte  
 lieferbar bis 6 m Länge

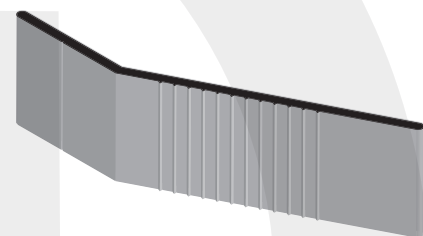
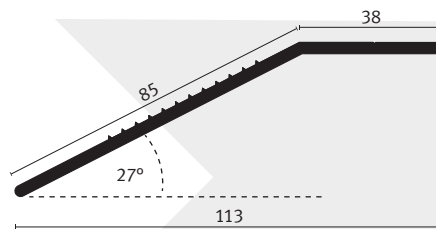

**Covering profile**

for 38 mm boards  
 max. length 6 m

**Profilè finition**

pour plaque  
 de 38 mm  
 longueur max. 6 m

**CR 22CD**

**Schiebetürprofil  
 oben**

lieferbar bis 6 m Länge  
 wahlweise Aufnahme von  
 Glas- oder Holzplatten  
 in 6 mm Stärke

**Aluminium panel  
 insert**

max. length 6 m  
 choice of glass or  
 wooden panels in  
 6 mm thickness

**Profilè pour porte  
 coulissante haute**

longueur max. 6 m  
 pour remplissage de  
 6 mm

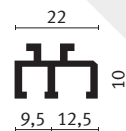

**CR 22SD**

**Schiebetür  
 Steckprofil**

lieferbar bis 6 m Länge  
 wahlweise Aufnahme von  
 Glas- oder Holzplatten  
 in 6 mm Stärke

**Aluminium panel  
 insert**

max. length 6 m  
 choice of glass or  
 wooden panels in  
 6 mm thickness

**Profilè insert  
 Aluminium**

longueur max. 6 m  
 pour remplissage de  
 6 mm

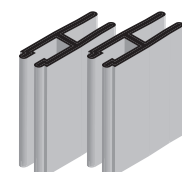



**CR 22RG**

**Schiebetürprofil  
 unten**

lieferbar bis 6 m Länge

**Bottom sliding  
 door profile**

max. length 6 m

**Profilé pour porte  
 coulissante basse**

longueur max. 6 m

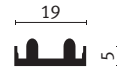

**CR 22CS**

**Schiebetürprofil  
 unten**

lieferbar bis 6 m Länge

**Bottom sliding  
 door profile**

max. length 6 m

**Profilé pour porte  
 coulissante basse**

longueur max. 6 m

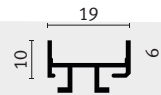

**Anwendungsbeispiel**  
 application example  
 exemple d'application

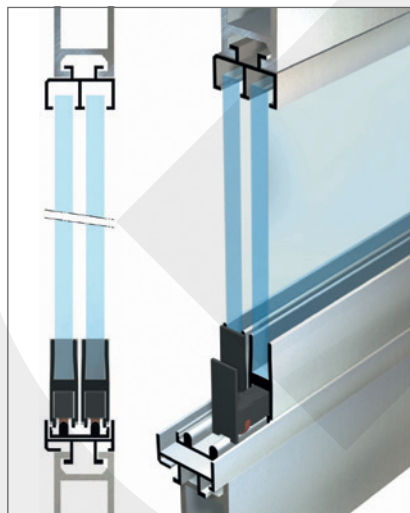

**CR 25CD**

**Schiebetürprofil**

lieferbar bis 6 m Länge  
 wahlweise Aufnahme von  
 Glas- oder Holzplatten  
 in 8 mm Stärke

**Profile for  
 sliding track**

max. length 6 m  
 choice of glass or  
 wooden panels in  
 8 mm thickness

**Profilé pour chemin  
 de roulement**

longueur max. 6 m  
 pour remplissage de  
 8 mm

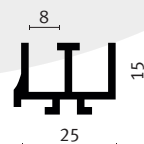

**FF ZARGE SMART**

**Zargenprofil**

lieferbar bis 6 m Länge

**Crossbeam profile**

max. length 6 m

**Profilè traverse**

Longueur max. 6 m

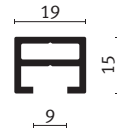

**FF ZARGE KONVEX**

**Zargenprofil**

lieferbar bis 6 m Länge

**Crossbeam profile**

max. length 6 m

**Profilè traverse**

Longueur max. 6 m

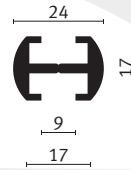

**FF ZARGE LIGHT**

**Zargenprofil**

lieferbar bis 6 m Länge

**Crossbeam profile**

max. length 6 m

**Profilè traverse**

Longueur max. 6 m

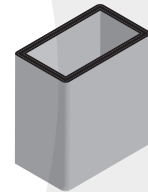
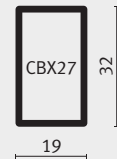

**FF ZARGE**

**Zargenprofil**

lieferbar bis 6 m Länge

**Crossbeam profile**

max. length 6 m

**Profilè traverse**

Longueur max. 6 m

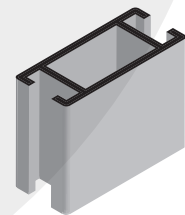
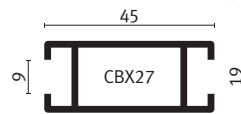

### FF 1 KANAL

**Tuchspannprofil mit Nut**

zzgl. Keder  
 lieferbar bis 6 m Länge

**Fabric tensioner with groove**

tube optional  
 max. length 6 m

**Profilé tendeur de tissu avec rainure**

tube en option  
 Longueur max. 6 m



### FF 2 KANAL RUND

**Tuchspannprofil mit Nut**

zzgl. Keder  
 lieferbar bis 6 m Länge

**Fabric tensioner with groove**

tube optional  
 max. length 6 m

**Profilé tendeur de tissu avec rainure**

tube en option  
 Longueur max. 6 m



### FF 2 KANAL FLACH 15x30

**Tuchspannprofil mit Nut**

zzgl. Keder  
 lieferbar bis 6 m Länge

**Fabric tensioner with groove**

tube optional  
 max. length 6 m

**Profilé tendeur de tissu avec rainure**

tube en option  
 Longueur max. 6 m



### FF 2 KANAL FLACH

**Tuchspannprofil mit Nut**

zzgl. Keder  
 lieferbar bis 6 m Länge

**Fabric tensioner with groove**

tube optional  
 max. length 6 m

**Profilé tendeur de tissu avec rainure**

tube en option  
 Longueur max. 6 m

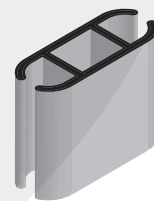

### FF 3 KANAL FLACH

**Tuchspannprofil mit Nut**

zzgl. Keder  
 lieferbar bis 6 m Länge

**Fabric tensioner with groove**

tube optional  
 max. length 6 m

**Profilé tendeur de tissu avec rainure**

tube en option  
 Longueur max. 6 m





---

WERBUNG UND TECHNIK

---

[WWW.PICOS-SYSTEMS.DE](http://WWW.PICOS-SYSTEMS.DE)

---

PICOS Grafik GmbH  
Hauptstraße 101  
53619 Rheinbreitbach  
Telefon +49 2224 98402-0