

# ZUBEHÖR



**CBX 15**

**Schloss**  
inkl. Schraube

**Lock**  
screws included

**Pince**  
avec vis incluse

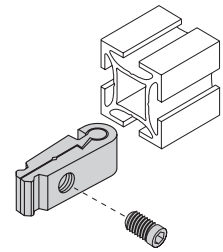
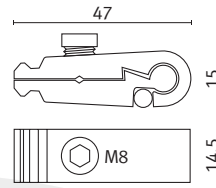

**CBX 15 45 L**

**Schrägschloss**  
45° - links  
inkl. Schraube

**Angled lock**  
45° - left  
screws included

**Pince oblique**  
45° - gauche  
avec vis incluse

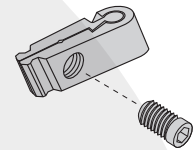
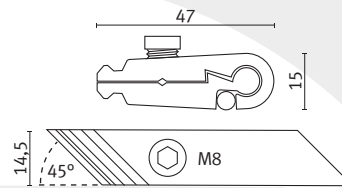

**CBX 15 45 R**

**Schrägschloss**  
45° - rechts  
inkl. Schraube

**Angled lock**  
45° - right  
screws included

**Pince oblique**  
45° - droite  
avec vis incluse

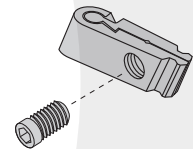
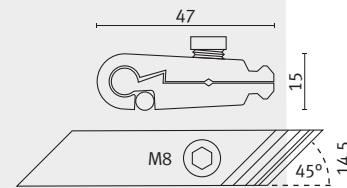

**CBX 15 60 L**

**Schrägschloss**  
60° - links  
inkl. Schraube

**Angled lock**  
60° - left  
screws included

**Pince oblique**  
60° - gauche  
avec vis incluse

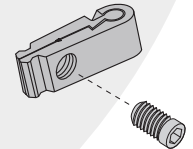
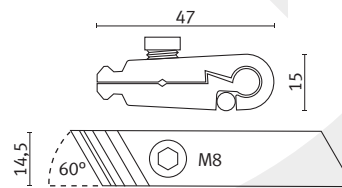

**CBX 15 60 R**

**Schrägschloss**  
60° - rechts  
inkl. Schraube

**Angled lock**  
60° - right  
screws included

**Pince oblique**  
60° - droite  
avec vis incluse

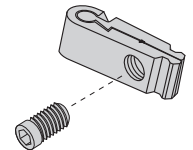
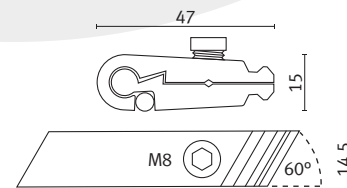

**CBX 20 M8**

**Schloss**  
inkl. Schraube

**Lock**  
screws included

**Pince**  
avec vis incluse

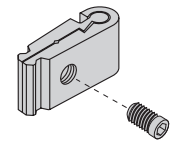
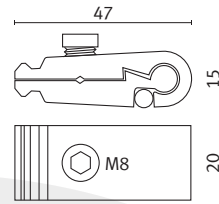

**CBX 20 M10**

**Schloss**  
inkl. Schraube

**Lock**  
screws included

**Pince**  
avec vis incluse

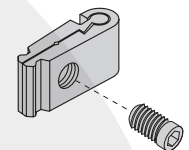
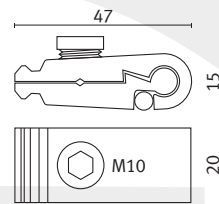

**CBX 25 M10**

**Schloss**  
inkl. Schraube  
für QV 911

**Lock**  
screws included  
for QV 911

**Pince**  
avec vis incluse  
pour QV 911

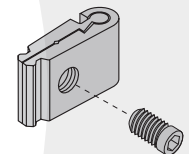
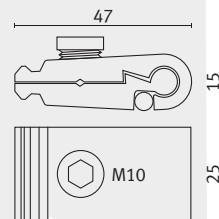

**CBX 27**

**Schloss**  
inkl. Schraube

**Lock**  
screws included

**Pince**  
avec vis incluse

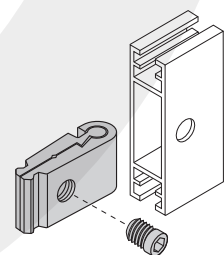
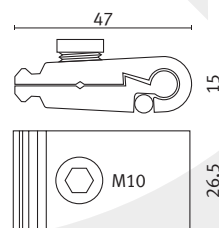

**CBX 27 45 L**

**Schrägschloss**  
45° - links  
inkl. Schraube

**Angled lock**  
45° - left  
screws included

**Pince oblique**  
45° - gauche  
avec vis incluse

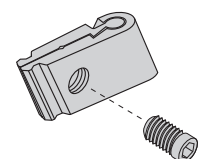
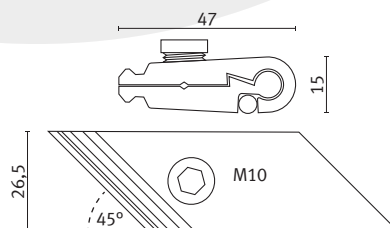

**CBX 27 45 R**

**Schrägschloss  
45° - rechts**  
inkl. Schraube

**Angled lock  
45° - right**  
screws included

**Pince oblique  
45° - droite**  
avec vis incluse

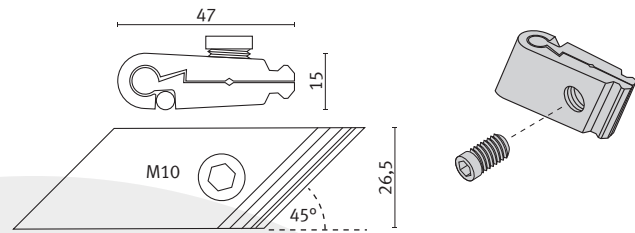

**CBX 27 60 L**

**Schrägschloss  
60° - links**  
inkl. Schraube

**Angled lock  
60° - left**  
screws included

**Pince oblique  
60° - gauche**  
avec vis incluse

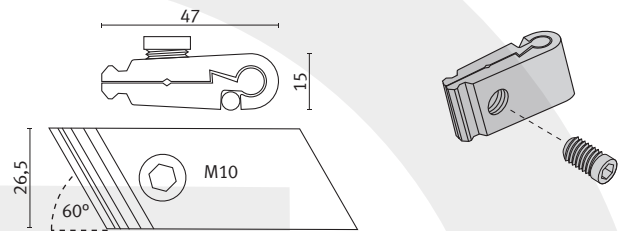

**CBX 27 60 R**

**Schrägschloss  
60° - rechts**  
inkl. Schraube

**Angled lock  
60° - right**  
screws included

**Pince oblique  
60° - droite**  
avec vis incluse

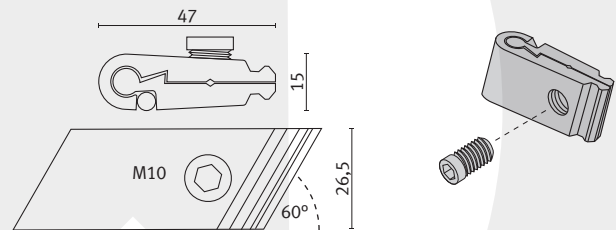

**CBX 39**

**Schloss**  
inkl. Schraube

**Lock**  
screws included

**Pince**  
avec vis incluse

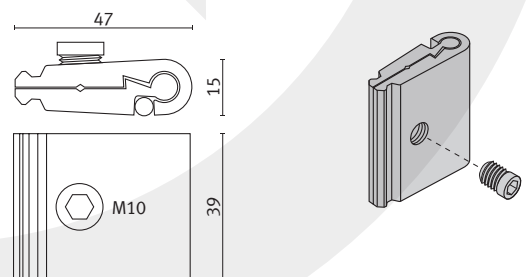

**CBX 39 45 L**

**Schrägschloss  
45° - links**  
inkl. Schraube

**Angled lock  
45° - left**  
screws included

**Pince oblique  
45° - gauche**  
avec vis incluse

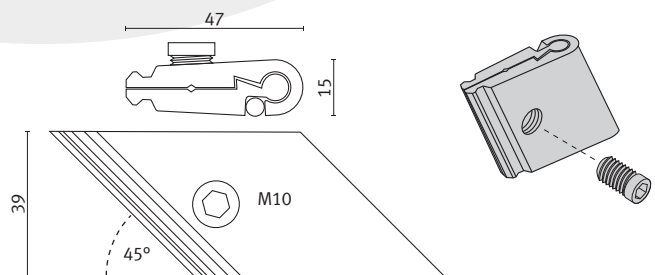

**CBX 39 45 R**

**Schrägschloss  
45° - rechts**  
inkl. Schraube

**Angled lock  
45° - right**  
screws included

**Pince oblique  
45° - droite**  
avec vis incluse

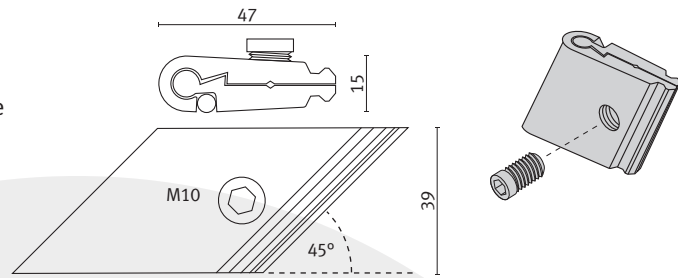

**CBX 39 60 L**

**Schrägschloss  
60° - links**  
inkl. Schraube

**Angled lock  
60° - left**  
screws included

**Pince oblique  
60° - gauche**  
avec vis incluse

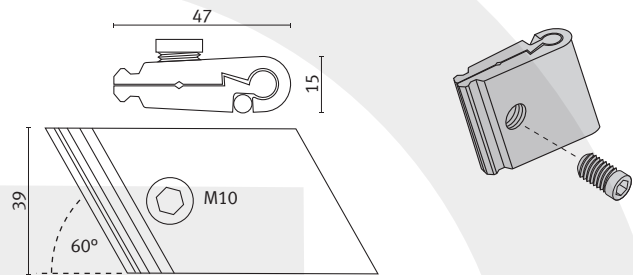

**CBX 39 60 R**

**Schrägschloss  
60° - rechts**  
inkl. Schraube

**Angled lock  
60° - right**  
screws included

**Pince oblique  
60° - droite**  
avec vis incluse

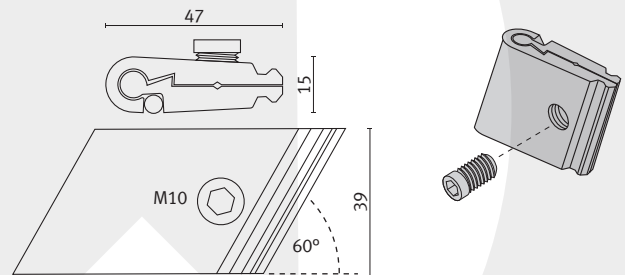

**QV 911**

**QV Verbinder**  
QV Verbinder  
mit CBX 25  
komplett  
beidseitig einsetzbar

**QV connector**  
QV connector  
with CBX 25  
complete  
can be used on  
both sides

**Raccord avec QV**  
Fixe crochet  
complet  
peut être utilisé  
des deux côtés

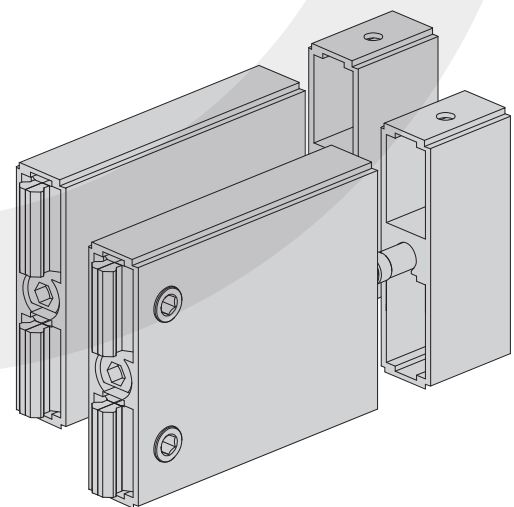

**TS RV1**

**Eckverbinder  
einfach**

Stahl, 90°  
inkl. Schrauben

**Corner connector**

Steel, 90°  
incl. screws

**Equerre d'assemblage**

Acier, 90°  
Vis incluses

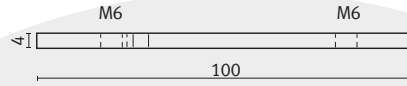
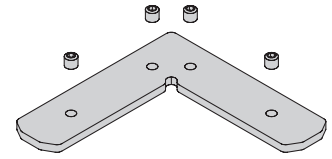

**TS RV2**

**Eckverbinder  
doppelt**

Stahl, 90°  
inkl. Schrauben

**Corner connector**

Steel, 90°  
incl. screws

**Equerre d'assemblage**

Acier, 90°  
Vis incluses

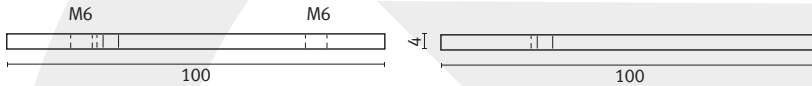
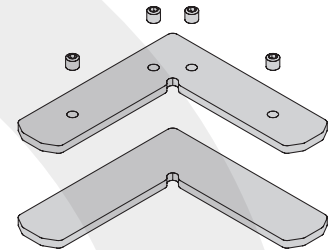

**TS RV3**

**Längsverbinder  
einfach**

inkl. Schrauben

**Extension piece**

incl. screws

**Manchon d'assemblage**

Vis incluses

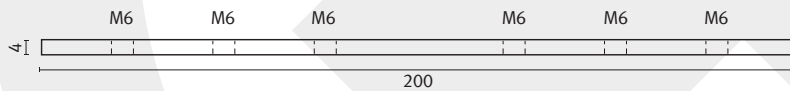
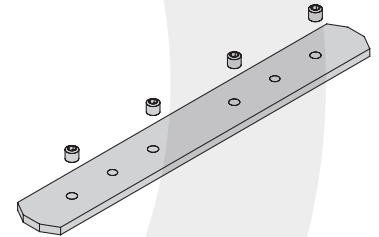

**TS RV4**

**Längsverbinder  
einfach**

inkl. Schrauben

**Extension piece**

incl. screws

**Manchon d'assemblage**

Vis incluses

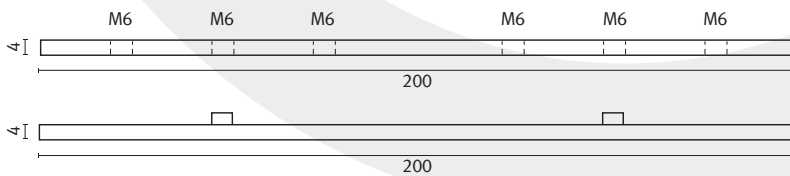
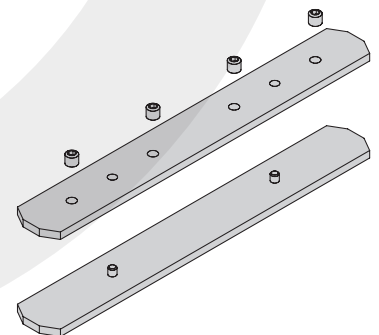

**TS V4**

**Werkzeugloser  
Verbinder**

Länge: 82 mm - für  
Tuchspannprofil 45 mm

**Tool-less  
connector**

Length: 82 mm - for  
tension fabric profil  
Thickness 45 mm

**Mollette d'assemblage  
autobloquante**

Longueur 82 mm - pour  
profilé d'épaisseur 45 mm

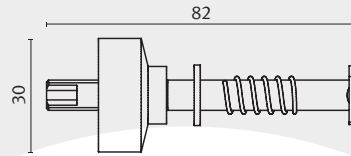
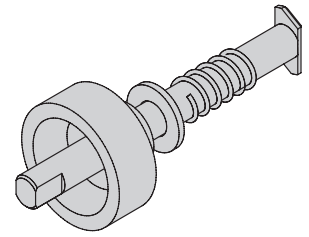

**TS V5**

**Werkzeugloser  
Verbinder**

Länge: 70 mm - für  
Tuchspannprofil 32 mm

**Tool-less  
connector**

Length: 70 mm - for  
tension fabric profil  
Thickness 32 mm

**Mollette d'assemblage  
autobloquante**

Longueur 70 mm - pour  
profilé d'épaisseur 32 mm

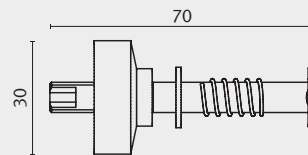
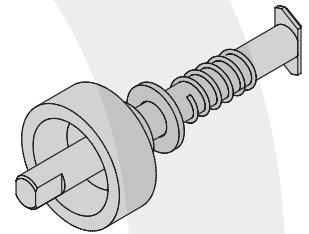

**TS RV5**

**Eckverbinder**

Stahl  
inkl. Schrauben

**Corner connector**

Steel  
incl. screws

**Equerre d'assemblage**

Acier  
Vis incluses

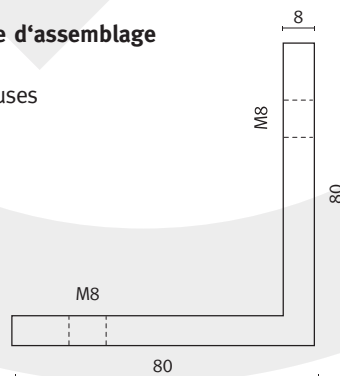
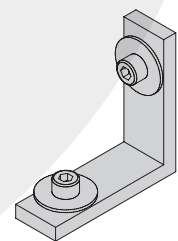

**PA 15 R**

**Winkelverbinder 0-180°**  
passend für 15 mm  
incl. Schrauben

**Connector 0-180°**  
for 15 mm  
screws included

**Pièce d'assemblage 0-180°**  
pour 15 mm  
avec vis

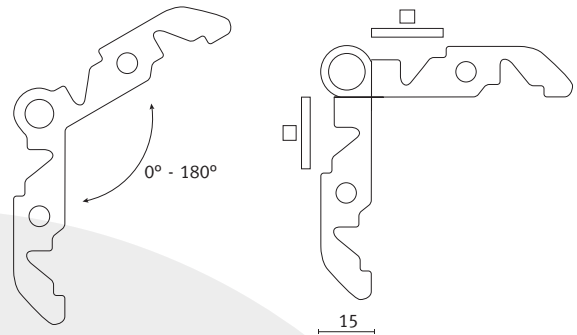

**PA 15 P**

**Winkelverbinder 90°**  
passend für 15 mm  
incl. Schrauben

**Connector 90°**  
for 15 mm  
screws included

**Pièce d'assemblage 90°**  
pour 15 mm  
avec vis

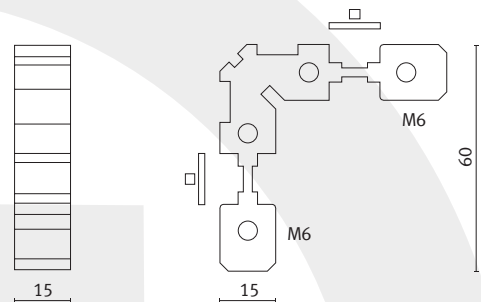

**PA 27**

**Winkelverbinder**  
inkl. Schrauben

**Mitre joint**  
screws included

**Equerre**  
avec vis ou bouton molletè

**Anwendungsbeispiel**  
application example  
exemple d'application

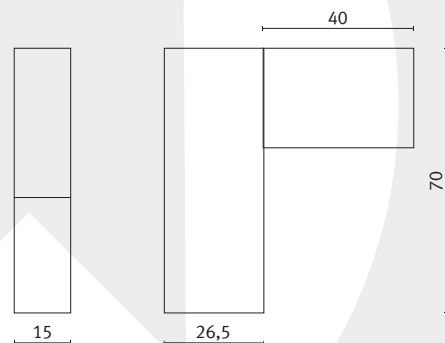
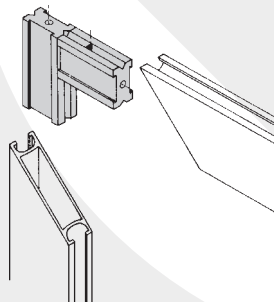

**M 1 70**

**Winkelverbinder**  
inkl. Schrauben

**Mitre joint**  
screws included

**Equerre**  
avec vis ou bouton molletè

**Anwendungsbeispiel**  
application example  
exemple d'application

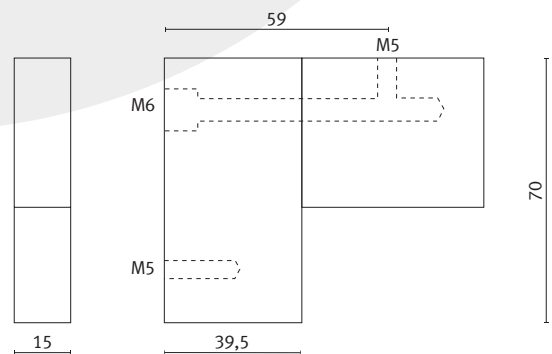
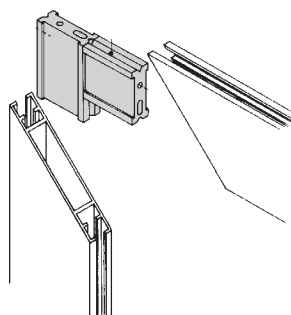



**TSV1**

**Winkelverbinder**  
inkl. Schrauben

**Mitre joint**  
screws included

**Equerre**  
avec vis ou bouton molleté

**Anwendungsbeispiel**  
application example  
exemple d'application

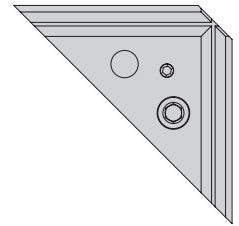
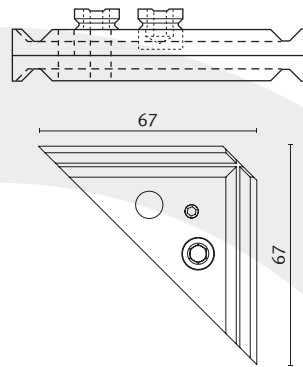
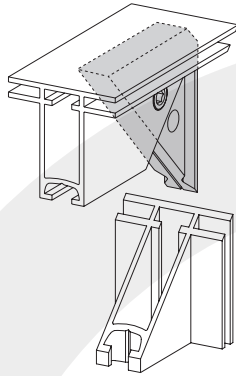

**3D DRUCK - VERBINDUNGSECKE - FF X-LIGHT**

**3D Druck Ecke**  
Verbindungsecke  
für Schiene FF-XLIGHT  
und FF-XLIGHT 45°

**3D Print corner**  
Connection corner  
for Rail FF-XLIGHT  
and FF-XLIGHT 45°

**Coin 3D**  
Coin de connexion  
pour Rail FF-XLIGHT  
et FF-XLIGHT 45°

Material: PLA Silber  
inkl. Schraube

Material: PLA silver  
incl. screw

Matériel : PLA silver  
incl. vis

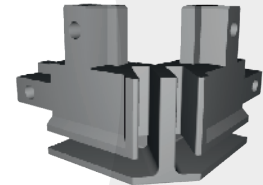
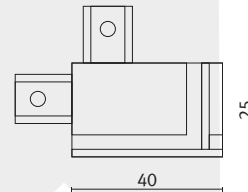

**3D DRUCK - VERBINDUNGSECKE - FF HEAVY**

**3D Druck Ecke**  
Verbindungsecke  
für Schiene FF-HEAVY  
und FF-HEAVY 45°

**3D Print corner**  
Connection corner  
for Rail FF-HEAVY  
and FF-HEAVY 45°

**Coin 3D**  
Coin de connexion  
pour Rail FF-HEAVY  
et FF-HEAVY 45°

Material: PLA Silber  
inkl. Schraube

Material: PLA silver  
incl. screw

Matériel : PLA silver  
incl. vis

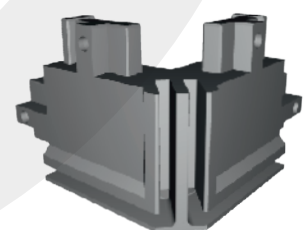
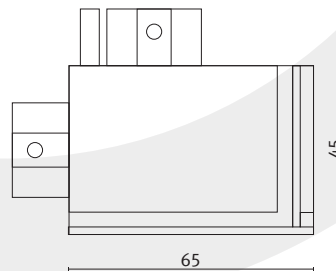

**PMP 15**

**Innenverbinder**  
für 15 mm x 15 mm

**Aluminium spigot**  
for 15 mm x 15 mm

**Manchon de raccordement**  
pour 15 mm x 15 mm

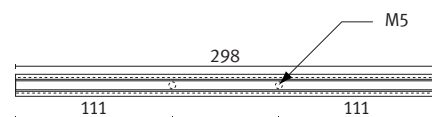
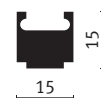

**PMP 1527**

**Innenverbinder**  
inkl. Schrauben

**Aluminium spigot**  
screws included

**Manchon de raccordement**  
avec vis

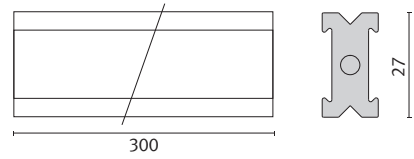

**V 23**

**Innenverbinder**  
inkl. Schrauben

**Aluminium spigot**  
screws included

**Manchon de raccordement**  
avec vis

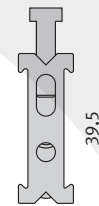

**Anwendungsbeispiel**  
application example  
exemple d'application

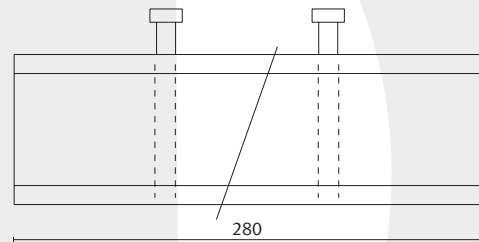
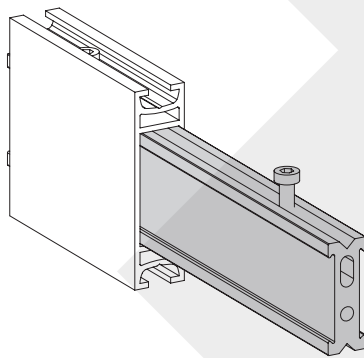

**V 15**

**Innenverbinder**  
für Q 914  
inkl. Schrauben

**Aluminium spigot**  
for Q 914  
screws included

**Manchon de raccordement**  
pour série Q 914  
avec vis

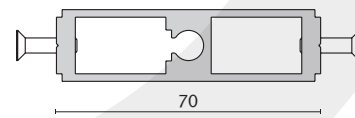

**Anwendungsbeispiel**  
application example  
exemple d'application

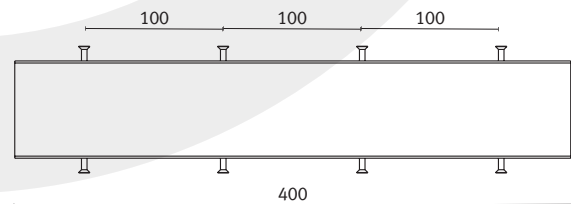
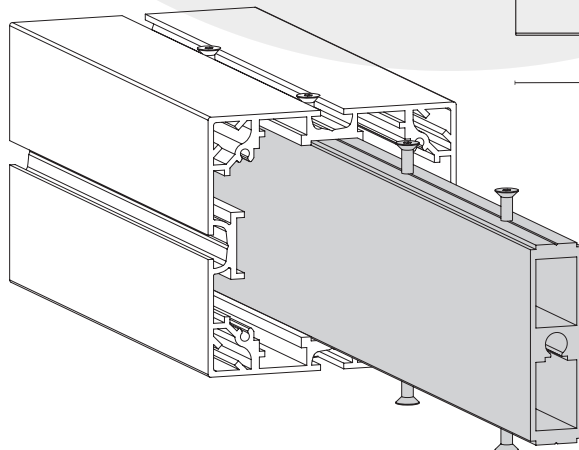

**V 16**

**Innenverbinder**  
für S 50  
inkl. Schraube

**Aluminium spigot**  
for S 50  
screws included

**Manchon de raccordement**  
pour S 50  
avec vis

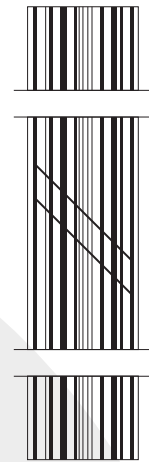

**Anwendungsbeispiel**  
application example  
exemple d'application

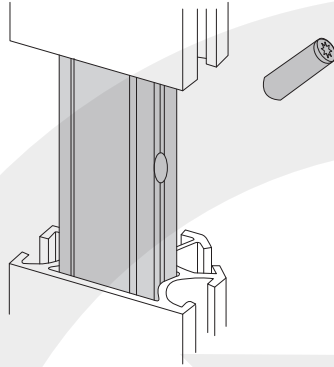

**PMP 8000**

**Innenverbinder**  
für S 80  
inkl. Schraube

**Aluminium spigot**  
for S 80  
screws included

**Manchon de raccordement**  
pour S 80  
avec vis

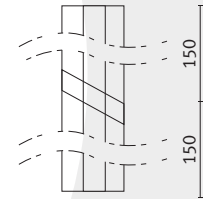

**Anwendungsbeispiel**  
application example  
exemple d'application

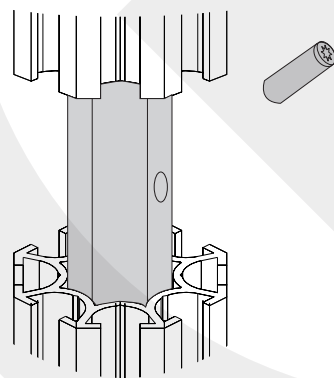

**V 31 45 + V 31 70**

**Verbinder**  
nachträglich montierbar  
incl. Schrauben

**Connector**  
for subsequent fitting  
screws included

**Pièce d'assemblage**  
pour montage ultérieur  
avec vis

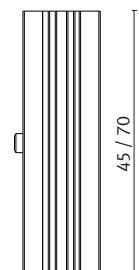
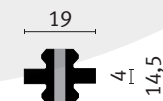

**Anwendungsbeispiel**  
application example  
exemple d'application

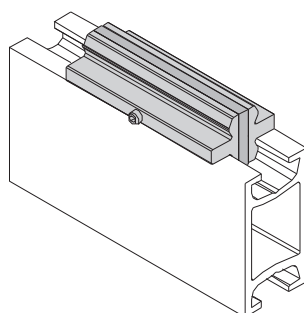

**1008**

**Nutstein M5**  
incl. Schraube

**Sliding block M5**  
screw included

**Coulisseau M5**  
avec vis

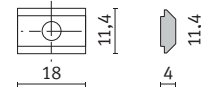

**1006**

**Verbinder**  
incl. Schraube

**Connector**  
screw included

**Pièce d'assemblage**  
avec vis

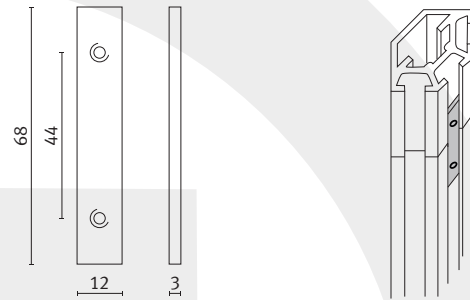

**PL 60**

**Profilverbinder**  
incl. Schrauben

**Pressure screw**  
screws included

**Pièce d'assemblage**  
avec vis

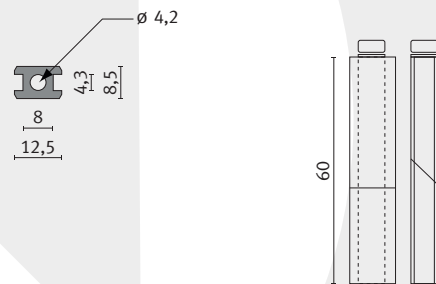

**PA 5**

**Auflagewinkel**  
incl. Schraube

**Shelf support**  
screw included

**Support étagère**  
avec vis

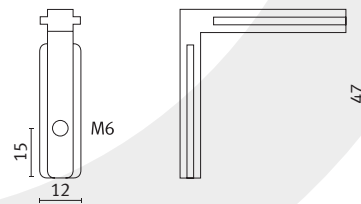

**SE 8 P**

**Auflagewinkel**  
incl. Schraube

**Shelf support**  
screw included

**Support étagère**  
avec vis

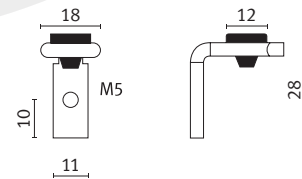

**SE 8 R**

**Hammerkopf-schraube**  
für Glas mit Gummi  
incl. Schrauben

**Bracket**  
with rubbering for  
glass shelving  
screws included

**Support étagère**  
pour verre avec  
caoutchouc  
et vis

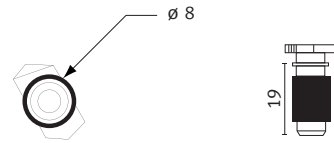

**SD 19**

**Vielzeckhaken**  
ohne Lochbohrung

**Universal hook**  
without 6 m

**Support**  
Plateau simple  
sans trou

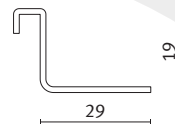

**APZ**

**Plattenhalter**  
5 - 20 mm

**Panel supports**  
5 - 20 mm

**Supports panneaux**  
5 - 20 mm

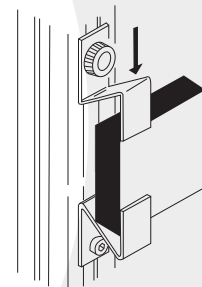
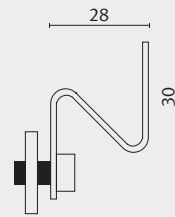

**1028**

**Feststeller**  
Gewinde M5

**Fastener**  
Thread M5

**Pièce de blocage**  
Filet M5



**H7**

**Blendenhaken**  
verstellbar

**Panel hook**  
adjustable

**Accroche panneau**  
réglable

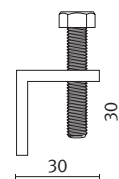
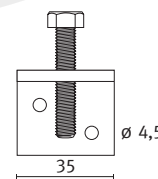

**AP 70**

**Blendhaken**

**Panel hook**

**Accroche panneau**

**Anwendungsbeispiel**  
application example  
exemple d'application

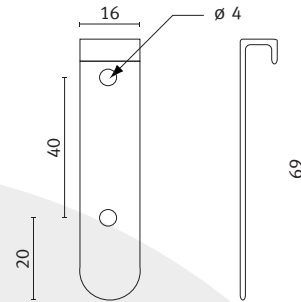
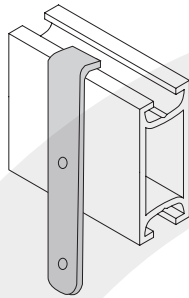

**RP 45 / RP 70 / RP 91 / RP 140**

**Anschlußstück**

**System connector**

**Pièce de raccordement**

**Anwendungsbeispiel**  
application example  
exemple d'application

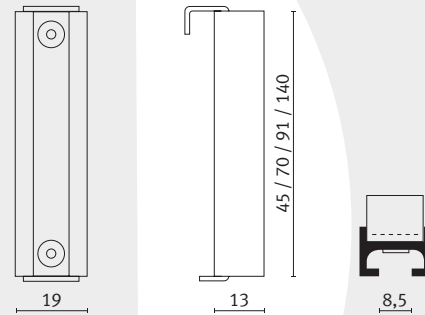
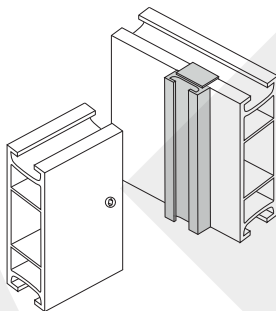

**SLV 13**

**Seilaufnahme**

nachträglich montierbar

**Wire adapter**

for subsequent fitting

**Support élingue**

pour montage ultérieur

**Anwendungsbeispiel**  
application example  
exemple d'application

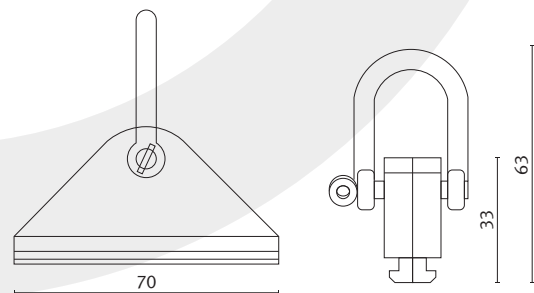
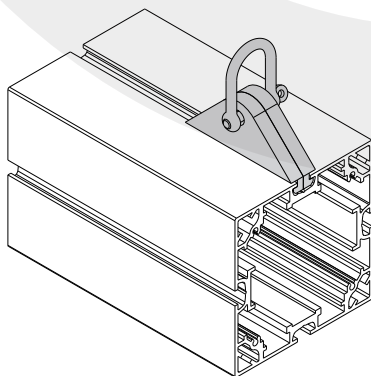

**PR 3540**

**Scharnier**  
wird für Anschlagtür  
benötigt

**Hinge**  
for crossbeam  
connection

**Charnière**  
alu GM pour porte  
sur paumelles

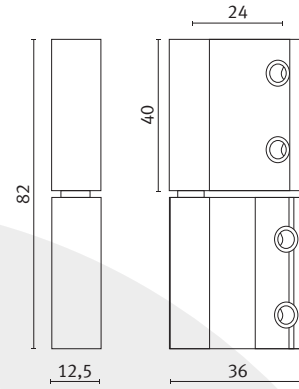

**PR 3640**

**Scharnier**  
nicht für den  
nachträglichen Einbau

**Hinge**

**Charnière**

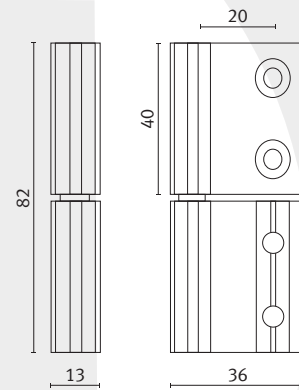

**PR 4540**

**Scharnier**

**Hinge**

**Charnière**

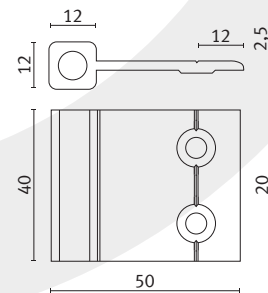

**CHR 1924**

**Scharnier**  
Stütze an Stütze

**Hinge**  
groove to groove  
connection

**Charnière**  
alu réversible à 180°  
montant / montant

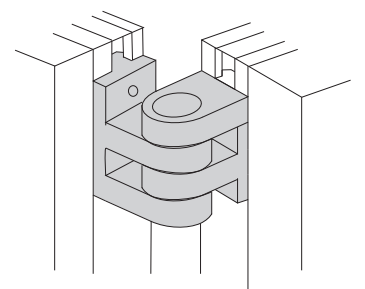
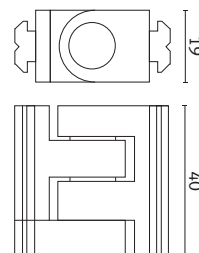

**CHR 60**

**Zahnstangenscharnier**  
Stütze an Stütze

**Cogwheel**  
groove to groove  
connection

**Charnière**  
alu réversible à 180°  
montant / montant

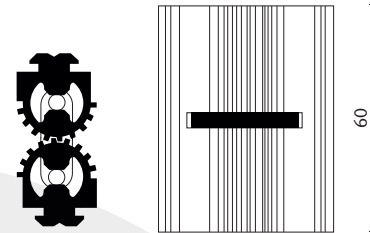

**CH 55**

**Glastürscharnier**  
1 Paar

**Top an  
bottom hinge**  
1 pair per glass door

**Charnière**  
pour glace, une paire

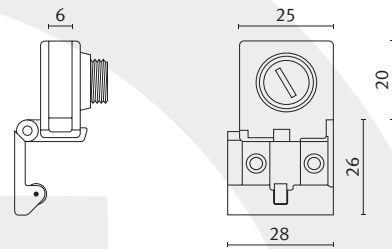

**CH 55 GRIFF**

**Glastürscharnier Griff**

**Hinge handle**

**Poignée à charnière**

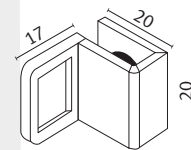

**SER 19**

**Lappenschloss**  
für 19 mm Türblatt

**Lever lock**  
for 19 mm door

**Serrure**  
pour panneau 19 mm

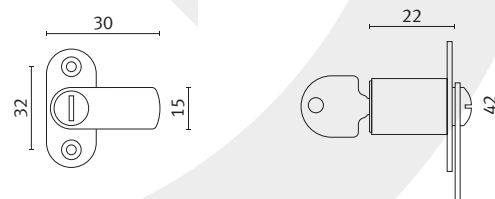

**SERCR 22**

**Laufschuhschloss**  
komplett mit Steckschloss  
und Schlüssel

**Lock**  
with safety lock  
and key

**Serrure**  
avec serrure et clef

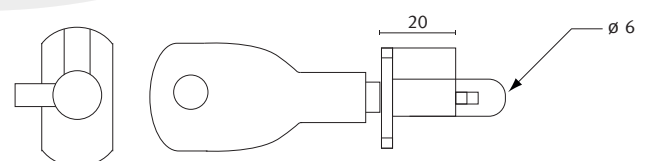



**SERCR 25**

**Steckschloss**  
für Glas / Holz

**Safety lock**  
for glass / wood

**Serrure**  
pour verre

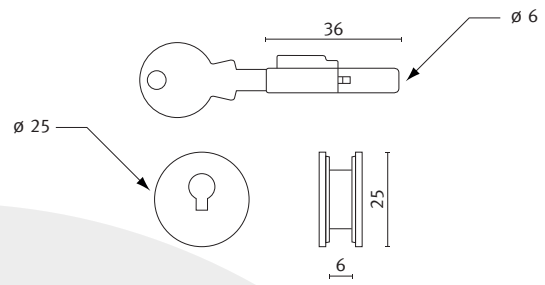

**SERCR PO**

**Steckschloss**  
für Glas / Holz

**Safety lock**  
for glass / wood

**Serrure**  
pour verre

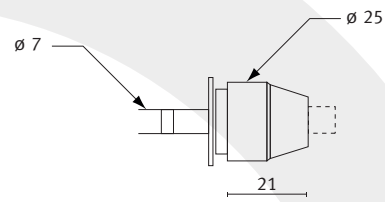

**POMA**

**Selbstklebender Griff**

**adhesive handle**

**poignée adhésive**

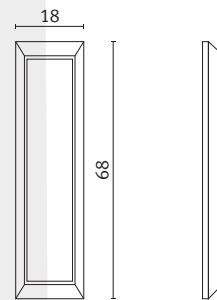

**FAM EINSEITIG**

**FAM Einseitig**  
Wandanschlußclip

**FAM Single-sided**  
Wall connection clip

**FAM partial**  
Clip de  
raccordement mural

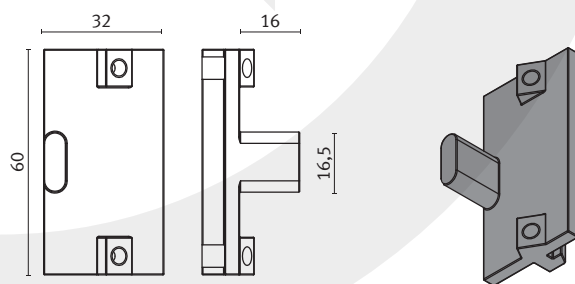

**FAM DOPPELSEITIG**

**FAM Doppelseitig**  
Wandanschlußclip

**FAM Double-sided**  
Wall connection clip

**FAM recto verso**  
Clip de  
raccordement mural

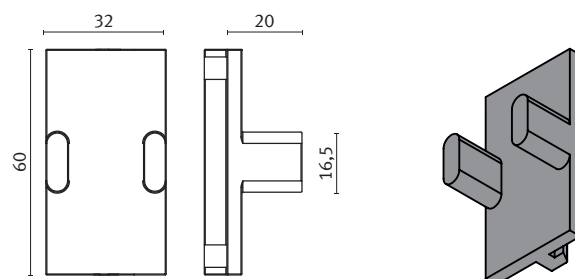

**FAF**

**FAF**  
Wandanschlußclip

**FAF**  
Wall connection clip

**FAF**  
Clip de  
raccordement mural

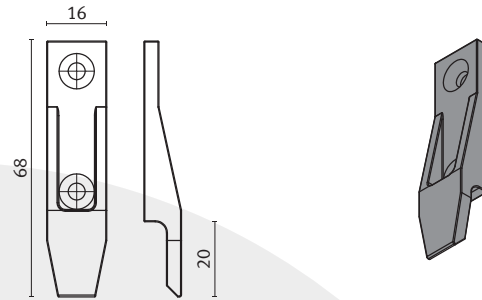

**SIGN HOLDER**

**Schildhalter**

**Sign holder**

**Porte-affiche**

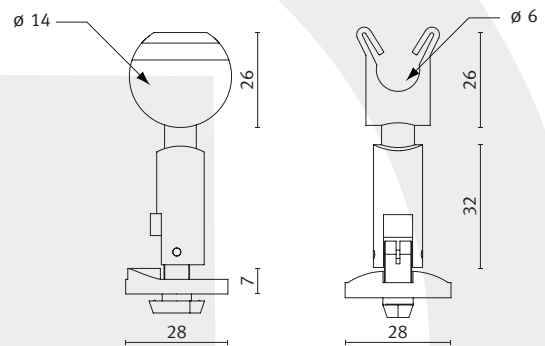

**T1**

**Anschlagtüre**

Die Anschlagtür wird incl. Türanschlagleiste geliefert. Bitte geben Sie den Anschlag mit DIN rechts oder DIN links an.

**Door**

Door constructed complete with door handle and cylinder lock DIN left or right

**Porte sur paumelles**

La porte sur paumelles Pour vos commandes préciser GP gauche poussant ou DP droite poussant.

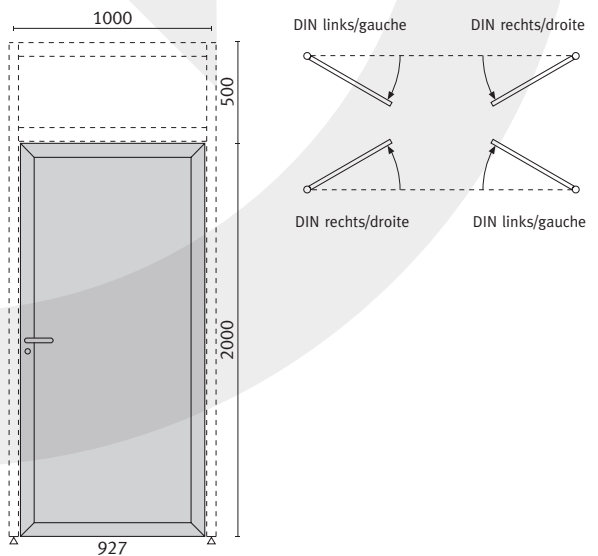

**T1 OF**

Tür ohne Füllung

Door infill panel

Door infill panel

**BEQ 1**

**Türgriffgarnitur**  
Aluminium eloxiert

**Door handle**  
Anodised aluminium

**Poignée pour**  
Aluminium anodisé

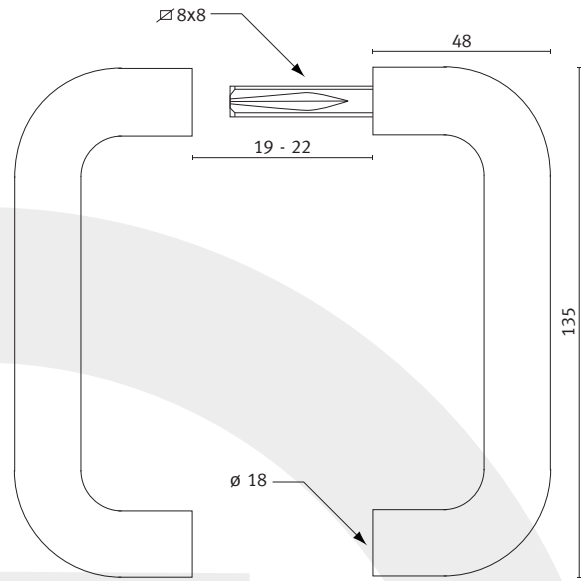

**CSP 1**

**Schlosszylinder**

**Cylinder lock**

**Serrure**

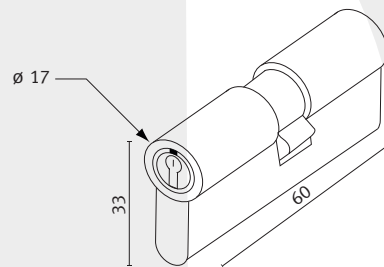

**SER BEQ 1**

**Riegelschloß**

**Lock**

**Serrure pour**

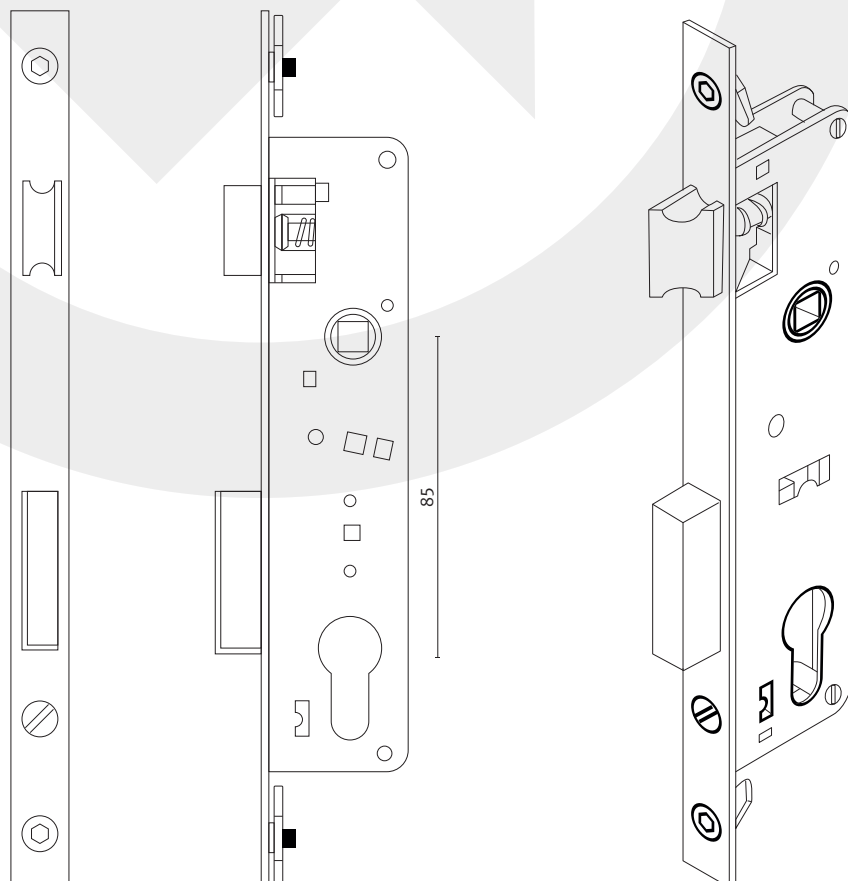

**PDOC CR**

Prospektschale

Pamphlet tray

Porte-documentation

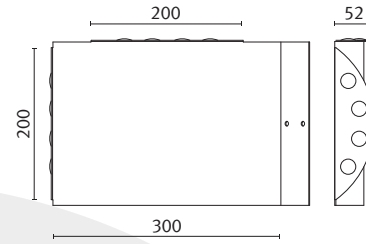

**G2 1000**

Tafelträger  
1000 mm

Panel support  
1000 mm

Support vestiaire  
1000 mm

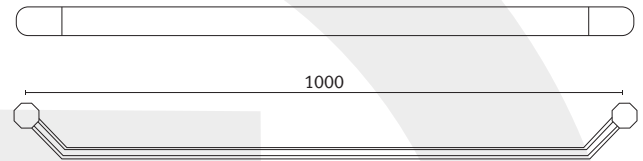

**DA 15**

Metalleinsatz

Steel insert

Douille acier

für Profil:  
for profile:  
pour le profil:

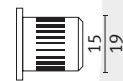
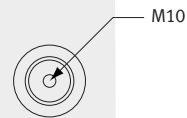
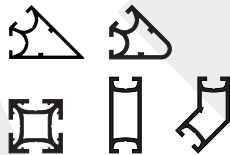

**DA 18**

Metalleinsatz

Steel insert

Douille acier

für Profil:  
for profile:  
pour le profil:

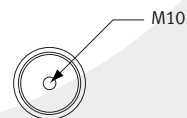
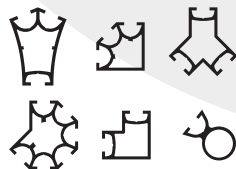

**DA 23**

**Metalleinsatz**

**Steel insert**

**Douille acier**

für Profil:  
for profile:  
pour le profil:

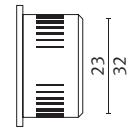
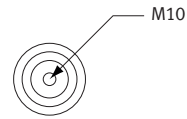
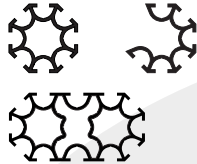

**VER 40 / 8**

**Verstellfuß**  
mit 8 mm  
Gewindeaufsatz

**Aluminium foot**  
with 8 mm thread

**Vérin aluminium**  
avec filet 8 mm

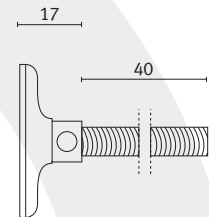
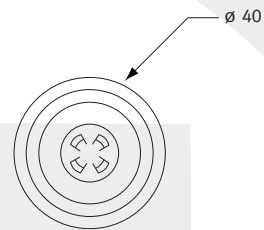

**VER 40 / 10**

**Verstellfuß**  
mit 10 mm  
Gewindeaufsatz

**Aluminium foot**  
with 10 mm thread

**Vérin aluminium**  
avec filet 10 mm

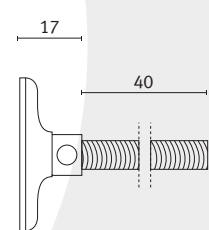
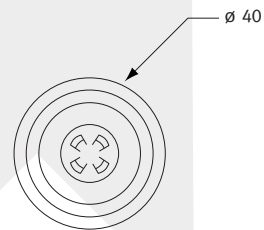

**SF 911 FR**

**Stellfuß**  
incl. Schraube

**Base plate**  
screw included

**Embase Q**  
avec vis

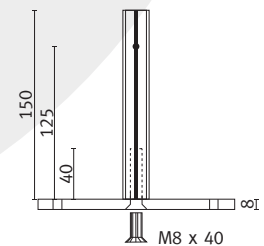
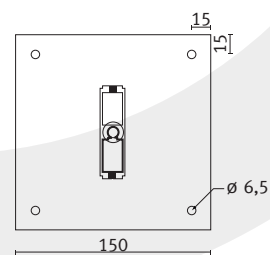

**EEA T035**

**Stahlendkappe**  
passend für T035

**Steel end piece**  
for T035

**Embout emboîtable acier**  
pour T035

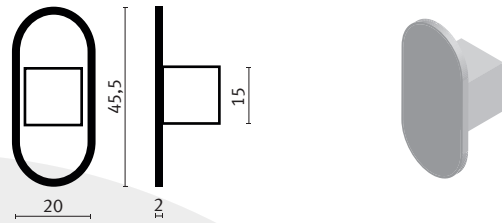

**ABDECKKAPPE - FF DUO 50 ECKE**

**Abdeckkappe für**  
FF DUO 50 ECKE

**Cover cap for**  
FF DUO 50 ECKE

**Embout pour**  
FF DUO 50 ECKE

**für Profil:**  
for profile:  
pour le profil:

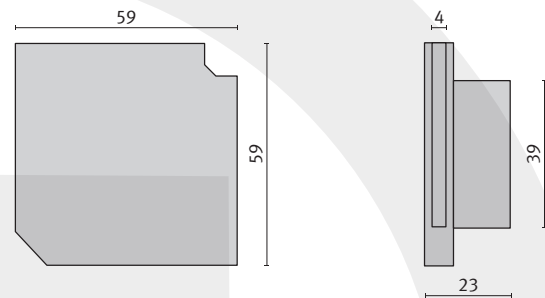
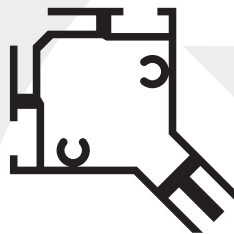

**EE3132 GRAU**

**Abdeckkappe**  
5 mm

**Plastic cap**  
5 mm

**Embout**  
5 mm

**für Profil:**  
for profile:  
pour le profil:



**EE1932 GRAU**

**Abdeckkappe**

**Plastic cap**

**Embout**

**für Profil:**  
for profile:  
pour le profil:

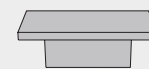

**EE1945 GRAU**

**Abdeckkappe**  
5 mm

**Plastic cap**  
5 mm

**Embout**  
5 mm

**für Profil:**  
for profile:  
pour le profil:

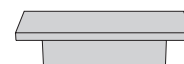

**EE1945 WEISS**

**Abdeckkappe**  
5 mm

**Plastic cap**  
5 mm

**Embout**  
5 mm

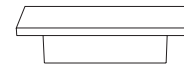

**für Profil:**  
for profile:  
pour le profil:



**EE1970 B GRAU**

**Abdeckkappe**

**Plastic cap**

**Embout**

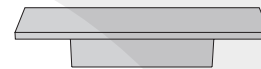

**für Profil:**  
for profile:  
pour le profil:



**AK80 WEISS**

**Abdeckkappe**  
5 mm

**Plastic cap**  
5 mm

**Embout**  
5 mm

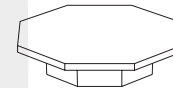

**für Profil:**  
for profile:  
pour le profil:



**AK80 GRAU**

**Abdeckkappe**  
5 mm

**Plastic cap**  
5 mm

**Embout**  
5 mm

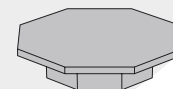

**für Profil:**  
for profile:  
pour le profil:



**VIS 8**

**Innensechskant**  
Gewinde M8

**Shelf support**  
Thread M8

**Support étagère**  
Filet M8



**VIS 10**

**Innensechskant**  
Gewinde M10

**Shelf support**  
Thread M10

**Support étagère**  
Filet M10



**STHC 10 x 20 Z**

**Innensechskant**  
Gewinde M10

**Shelf support**  
Thread M10

**Support étagère**  
Filet M10

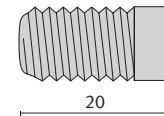



**CHB 300**

Konsole

Bracket

Console

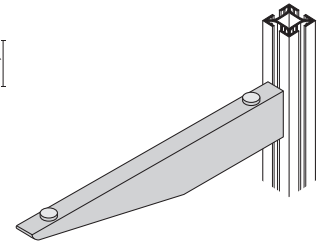
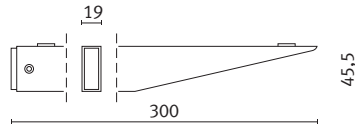

**CHB 500**

Konsole

Bracket

Console

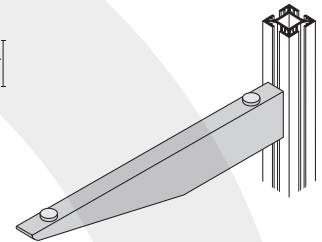
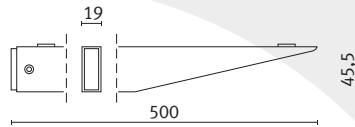

**CHD 150**

Konsole

Bracket

Console

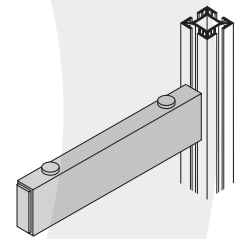
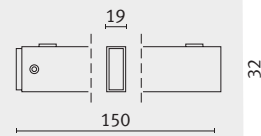

**CHD 200**

Konsole

Bracket

Console

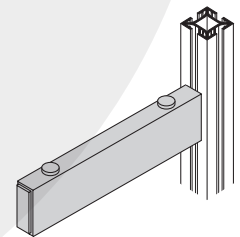
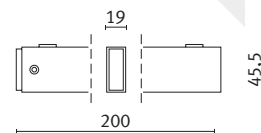

**RR 4**

**Paßprofil hart  
Kunststoff schwarz**  
für 4 mm Glas / Plexi  
lieferbar bis 4 m Länge

**Groove reducer**  
max. length 4 m

**Les réducteurs de rainure**  
Longueur max. 4 m



**Anwendungsbeispiel**  
application example  
exemple d'application

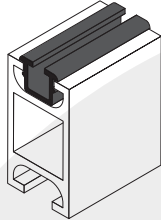

**RR 6**

**Paßprofil hart  
Kunststoff schwarz**  
für 6 mm Glas / Plexi  
lieferbar bis 4 m Länge

**Groove reducer**  
max. length 4 m

**Les réducteurs de rainure**  
Longueur max. 4 m



**803**

**Auflageprofil  
Kunststoff schwarz**  
lieferbar bis 4 m Länge

**Support profile  
Plastic black**  
max. length 4 m

**Profilè de soutien  
Plastique noir**  
Longueur max. 4 m

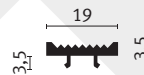

**Anwendungsbeispiel**  
application example  
exemple d'application

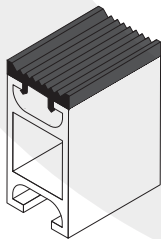

**PL**

**Paßprofil hart  
Kunststoff grau**  
für 6 - 8 mm Glas / Plexi  
zum nachträglichen Einbau  
lieferbar bis 4 m Länge

**Groove reducer**  
grey  
max. length 4 m

**Les réducteurs de rainure**  
gris  
Longueur max. 4 m

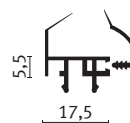

**PC**

**Kabelkanal**

grau  
lieferbar bis 4 m Länge

**Cable canal**

grey  
max. length 4 m

**Profilè passage de câbles**

gris  
Longueur max. 4 m

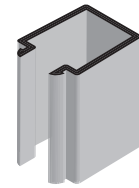
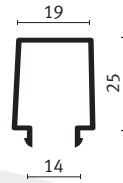

**Anwendungsbeispiel**

application example  
exemple d'application

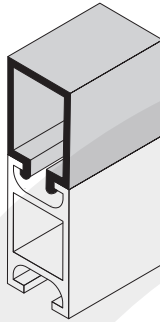

**BRP 8**

**Nutfüllprofil**

Farben:  
- Schwarz  
- Weiss  
- Rot  
- Grün  
- Blau

**Groove Cover**

Color:  
- Black  
- White  
- Red  
- Green  
- Blue

**Bouche rainure**

Coloris:  
- Noir  
- Blanc  
- Rouge  
- Vert  
- Bleu

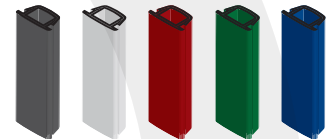

**CR 2508**

**Gummikeder grau**

für CR25CD und T035  
lieferbar bis 2 m Länge

**Rubber rope grey**

for CR25CD and T035  
max. length 2 m

**Corde caoutchouc gris**

Pour CR25CD et T035  
Longueur max. 2 m





---

WERBUNG UND TECHNIK

---

[WWW.PICOS-SYSTEMS.DE](http://WWW.PICOS-SYSTEMS.DE)

---

PICOS Grafik GmbH  
Hauptstraße 101  
53619 Rheinbreitbach  
Telefon +49 2224 98402-0